

Tektronix

**TDS200
Operator Training Kit Manual
071-1089-00**

This product training document file is protected by Copyright © Tektronix, Inc. All rights reserved.

End users of this Tektronix product training document file are permitted to print any portion of this file or copy the electronic file for personal use. Print or electronic reproduction of this product training document file for resale is strictly prohibited.

Tektronix, Inc., P.O. Box 500, Beaverton, OR 97077

TEKTRONIX and TEK are registered trademarks of Tektronix, Inc.

WARRANTY

Tektronix warrants that the parts, assemblies and supplies (“products”) that it manufactures and sells will be free from defects in materials and workmanship for a period of three (3) months from the date of shipment. If a product proves defective during this warranty period, Tektronix, at its option, either will repair the defective product without charge for parts and labor, or will provide a replacement in exchange for the defective product.

In order to obtain service under this warranty, Customer must notify Tektronix of the defect before the expiration of the warranty period and make suitable arrangements for the performance of service. Customer shall be responsible for packaging and shipping the defective product to the service center designated by Tektronix, with shipping charges prepaid. Tektronix shall pay for the return of the product to Customer if the shipment is to a location within the country in which the Tektronix service center is located. Customer shall be responsible for paying all shipping charges, duties, taxes, and any other charges for products returned to any other locations.

This warranty shall not apply to any defect, failure or damage caused by improper use or improper or inadequate maintenance and care. Tektronix shall not be obligated to furnish service under this warranty a) to repair damage resulting from attempts by personnel other than Tektronix representatives to install, repair or service the product; b) to repair damage resulting from improper use or connection to incompatible equipment; c) to repair any damage or malfunction caused by the use of non-Tektronix supplies; or d) to service a product that has been modified or integrated with other products when the effect of such modification or integration increases the time or difficulty of servicing the product.

THIS WARRANTY IS GIVEN BY TEKTRONIX IN LIEU OF ANY OTHER WARRANTIES, EXPRESS OR IMPLIED. TEKTRONIX AND ITS VENDORS DISCLAIM ANY IMPLIED WARRANTIES OF MERCHANTABILITY OR FITNESS FOR A PARTICULAR PURPOSE. TEKTRONIX’ RESPONSIBILITY TO REPAIR OR REPLACE DEFECTIVE PRODUCTS IS THE SOLE AND EXCLUSIVE REMEDY PROVIDED TO THE CUSTOMER FOR BREACH OF THIS WARRANTY. TEKTRONIX AND ITS VENDORS WILL NOT BE LIABLE FOR ANY INDIRECT, SPECIAL, INCIDENTAL, OR CONSEQUENTIAL DAMAGES IRRESPECTIVE OF WHETHER TEKTRONIX OR THE VENDOR HAS ADVANCE NOTICE OF THE POSSIBILITY OF SUCH DAMAGES.

General Safety Summary

Review the following safety precautions to avoid injury and prevent damage to this product or any products connected to it. To avoid potential hazards, use this product only as specified.

While using this product, you may need to access other parts of the system. Read the *General Safety Summary* in other system manuals for warnings and cautions related to operating the system.

To Avoid Fire or Personal Injury

Connect and Disconnect Properly. Do not connect or disconnect probes or test leads while they are connected to a voltage source.

Connect the ground lead of the probe to earth ground only.

Replace Batteries Properly. Replace batteries only with the proper type and rating specified.

Use Proper AC Adapter. Use only the AC adapter specified for this product.

Use Proper Fuse. Use only the fuse type and rating specified for this product.

Avoid Exposed Circuitry. Do not touch exposed connections and components when power is present.

Do Not Operate With Suspected Failures. If you suspect there is damage to this product, have it inspected by qualified service personnel.

Do Not Operate in Wet/Damp Conditions.

Do Not Operate in an Explosive Atmosphere.

Keep Product Surfaces Clean and Dry.

Safety Terms and Symbols

Terms in This Manual. These terms may appear in this manual:



WARNING. *Warning statements identify conditions or practices that could result in injury or loss of life.*



CAUTION. *Caution statements identify conditions or practices that could result in damage to this product or other property.*

Terms on the Product. These terms may appear on the product:

DANGER indicates an injury hazard immediately accessible as you read the marking.

WARNING indicates an injury hazard not immediately accessible as you read the marking.

CAUTION indicates a hazard to property including the product.

Symbols on the Product. These symbols may appear on the product:



CAUTION
Refer to Manual



Standby



Contacting Tektronix

Phone 1-800-833-9200*

Address Tektronix, Inc.
Department or name (if known)
14200 SW Karl Braun Drive
P.O. Box 500
Beaverton, OR 97077
USA

Web site www.tektronix.com

Sales support 1-800-833-9200, select option 1*

Service support 1-800-833-9200, select option 2*

Technical support Email: techsupport@tektronix.com
1-800-833-9200, select option 3*
1-503-627-2400
6:00 a.m. - 5:00 p.m. Pacific time

* **This phone number is toll free in North America. After office hours, please leave a voice mail message. Outside North America, contact a Tektronix sales office or distributor; see the Tektronix web site for a list of offices.**

Table of Contents

Introduction to Oscilloscopes and Probes.....	1-1
Getting to Know Oscilloscopes	1-2
Introduction to Oscilloscopes.....	1-2
Types of Oscilloscopes.....	1-5
Oscilloscope Terminology	1-12
Getting to Know Probes	1-20
Introduction to Probes	1-20
Types of Voltage Probes	1-21
How Probes Affect Measurements.....	1-24
Summary	1-27
Getting Started with TDS200 Oscilloscopes	2-1
Setting Up TDS200 Oscilloscopes and Probes	2-2
Introduction to TDS200 Oscilloscopes	2-2
Setting Up a TDS200 Oscilloscope	2-7
Primary Controls	2-23
VERTICAL Controls.....	2-23
HORIZONTAL Controls	2-34
TRIGGER Controls	2-39
Menu Function Controls	2-46
Summary	2-64
Using VERTICAL Controls	3-1
VERTICAL Control Knobs.....	3-2
Setting Up VERTICAL Controls.....	3-3
Switching the Input Coupling	3-5

VERTICAL Control MENU Buttons	3-9
Modifying the Vertical Scale of a Displayed Waveform...	3-9
MATH MENU Controls	3-11
Adding Two Waveforms	3-11
Subtracting Two Waveforms	3-14
Performing FFT Operations	3-18
Summary	3-22
Using HORIZONTAL Controls	4-1
HORIZONTAL Control Knobs	4-2
Setting Up HORIZONTAL Controls	4-4
Setting the Delay Time for a Waveform	4-6
HORIZONTAL Control MENU Buttons	4-9
Expanding the Waveform Display	4-9
Summary	4-12
Using TRIGGER Controls	5-1
Trigger Holdoff Controls	5-2
Setting Up TRIGGER Controls	5-3
Assigning Trigger Holdoff	5-6
Assigning Trigger Holdoff With an AM Signal	5-8
TRIGGER Control MENU Buttons	5-13
Using an External Trigger	5-13
Selecting a Trigger Type	5-17
Selecting the Signal Coupling for a Trigger	5-20
Summary	5-23

Using Menu Function Controls	6-1
ACQUIRE Menu Function Controls	6-2
Using the Average Acquisition Mode	6-3
Using the Peak Detect Acquisition Mode	6-7
Step Response	6-10
DISPLAY Menu Function Controls	6-15
Selecting the Display Type	6-15
Using Persistence	6-18
Using the XY Display Mode	6-21
CURSOR Menu Function Controls	6-24
Measuring the Vertical Scale	6-24
Measuring the Horizontal Scale	6-27
Measuring Pulse Width	6-29
Measuring Rise Time	6-32
MEASURE Menu Function Controls	6-36
Taking Automatic Measurements	6-36
SAVE/RECALL Menu Function Controls	6-39
Saving and Recalling a Setup	6-39
Saving and Recalling a Waveform	6-43
UTILITY Menu Function Controls	6-46
Displaying the System Status	6-46
Summary	6-49
Appendix A: Training 1 Signal Board: Signal Definitions	A-1
Appendix B: Glossary	B-1

1

Introduction to Oscilloscopes and Probes

The environment around us contains various energy sources, such as electronic appliances that generate signals. Oscilloscopes allow you to observe these signals to analyze the performance of these energy sources. This module introduces oscilloscopes and the methods to measure electrical signals by using oscilloscopes and associated probes.

This module includes the following sections:

- Getting to Know Oscilloscopes
- Getting to Know Probes

1

Introduction to Oscilloscopes and Probes

Getting to Know Oscilloscopes

This section provides an introduction to oscilloscopes. It also describes the different types of oscilloscopes and how they function. This section includes the following topics:

- Introduction to Oscilloscopes
- Types of Oscilloscopes
- Oscilloscope Terminology

Introduction to Oscilloscopes

You use an oscilloscope to display electrical signals as waveforms. A waveform is a graphical representation of a wave.

An oscilloscope receives an electrical signal and converts it into a waveform. The waveform represents the change in voltage with time on an oscilloscope display screen.

You can use an oscilloscope to determine the following:

- The frequency of an oscillating signal
- The malfunctioning component in an electrical circuit
- Whether the signal is direct current (DC) or alternating current (AC)
- What part of the signal is noise

You can also use oscilloscopes to measure electrical signals in response to physical stimuli, such as sound, mechanical stress, pressure, light, or heat. For example, a television technician can use an oscilloscope to measure signals from the television circuit board. A medical researcher can use an oscilloscope to measure brain waves.

1

Introduction to Oscilloscopes and Probes

An oscilloscope contains various controls that help you analyze waveforms, which are displayed on a graphical grid. This graphical grid is called a graticule. The vertical or Y-axis of the graticule typically represents voltage. The horizontal or X-axis typically represents time.

Figure 1.1 shows how an oscilloscope displays voltage and time.

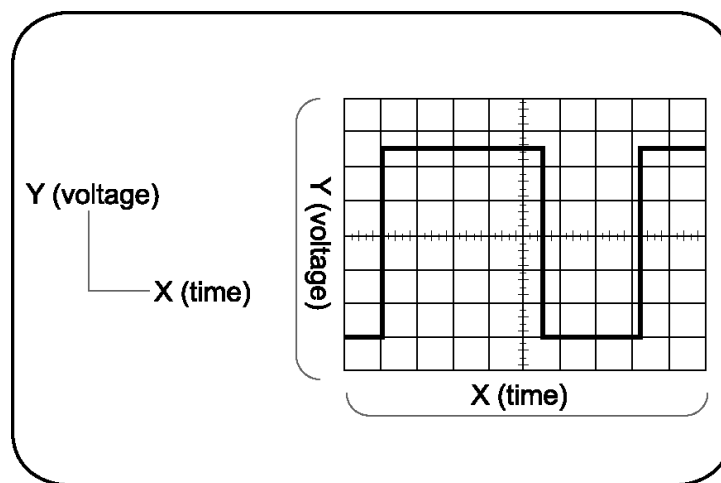

Figure 1.1: Oscilloscope display

Types of Oscilloscopes

Electronic equipment can be categorized into two types, analog and digital. Analog equipment use variable voltages while digital equipment use binary numbers that represent voltage samples. Similarly, oscilloscopes are categorized into analog and digital.

Figure 1.2 shows the difference between analog and digital oscilloscopes.

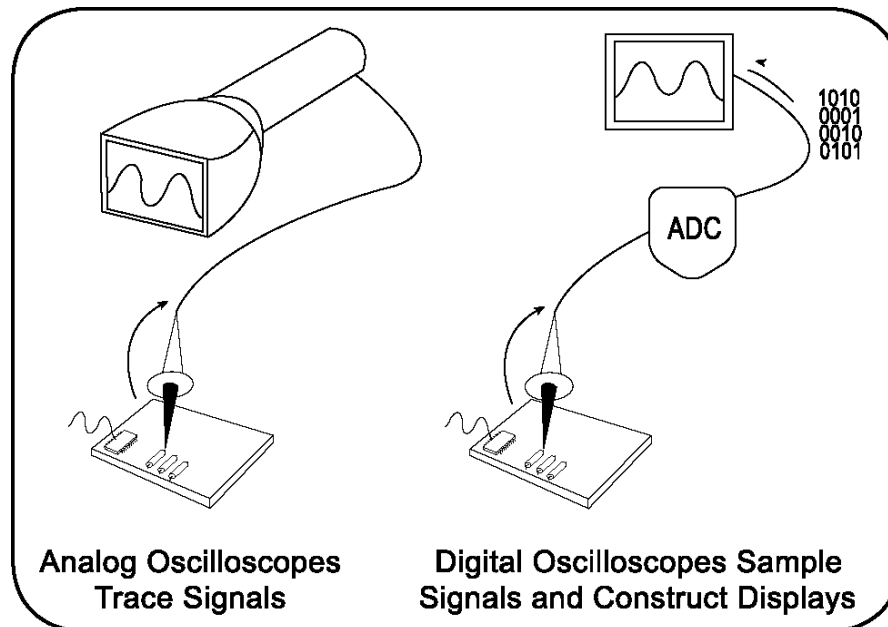

Figure 1.2: Analog and digital oscilloscopes

1

Introduction to Oscilloscopes and Probes

Analog Oscilloscopes

Let us look at how analog oscilloscopes work. Figure 1.3 shows a diagram of an analog oscilloscope.

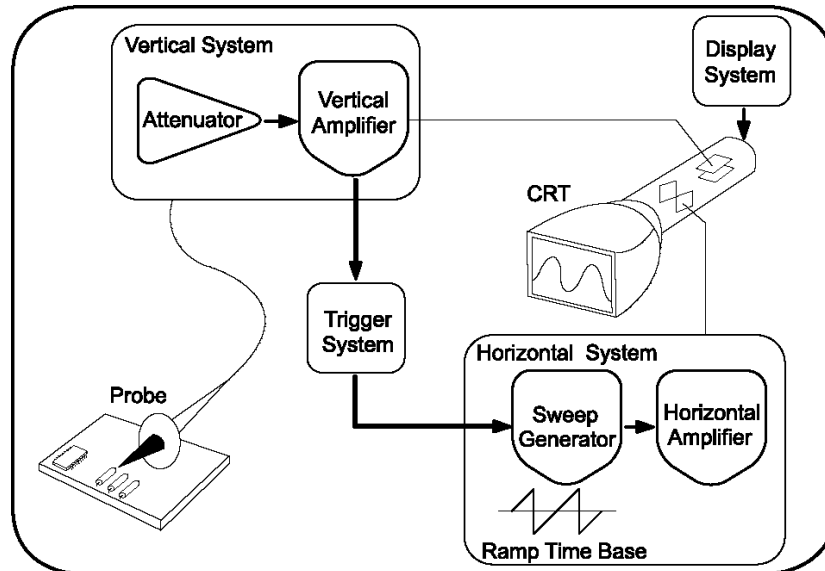

Figure 1.3: Block diagram of analog oscilloscopes

When you connect an analog oscilloscope to a circuit, the voltage signal from the circuit travels to the vertical deflection plates of the oscilloscope screen, which is a phosphor-coated cathode-ray tube (CRT). As a result, when an electron beam hits the phosphor inside the CRT, the beam creates a glowing dot. When you apply voltage to the deflection plates, the glowing dot moves.

A positive voltage causes the dot to move up and a negative voltage causes the dot to move down. The signal also travels to a trigger system, which initiates a horizontal sweep. The trigger causes the time base on the X-axis of the display grid to move the glowing dot across the screen from left to right within a specified time interval. When many sweeps occur in a rapid sequence, the movement of the glowing dot blends into a solid line. Together, the horizontal sweeping and vertical deflecting actions are displayed as a graph of the signal on the screen.

You use triggering to stabilize a repeating signal. Proper triggering ensures that the sweep begins at the same point of a repeating signal, to show a stable waveform.

Figure 1.4 shows triggered and untriggered waveforms.

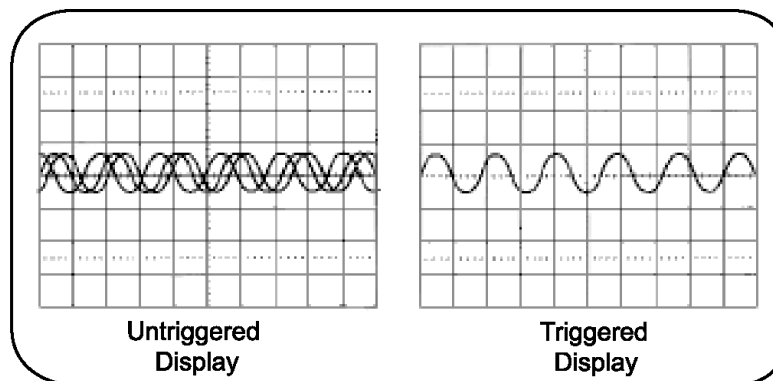

Figure 1.4: Untriggered and triggered display

1

Introduction to Oscilloscopes and Probes

In analog oscilloscopes, the CRT limits the range of sine wave frequencies that the oscilloscope can display. At low frequencies, the signal appears as a bright, slow-moving dot that does not display the waveform. When signal frequencies exceed the display speed of the CRT, the displayed signal is either distorted, attenuated, or both.

You can use an analog oscilloscope to display rapidly varying signals in real time. The phosphor-based display of an analog oscilloscope has an intensity grading, which makes the trace brighter wherever the signal features occur most frequently. You can then distinguish between signal details by observing the intensity levels of the displayed waveform.

Digital Oscilloscopes

In contrast to analog oscilloscopes, digital oscilloscopes use an analog-to-digital converter (ADC). An ADC converts the voltage being measured into a digital format. A digital oscilloscope acquires a waveform as a series of signal samples. It stores these signal samples in its memory and then reassembles the waveform for viewing on the screen.

Digital oscilloscopes are categorized into two types, digital storage oscilloscopes (DSO) and digital phosphor oscilloscopes (DPO). Let us look at how these two types of digital oscilloscopes work.

Digital Storage Oscilloscopes

In a DSO, an ADC takes samples of the signal at discrete points in time and converts the voltage at these points to digital values called sample points. The DSO contains a sample clock that determines the frequency at which the ADC takes samples. The rate at which the ADC takes samples is called the sample rate and is measured in samples per second.

The sample points from the ADC are stored in memory as waveform points. These waveform points make one waveform record. The number of waveform points used to make a waveform record is called the record length. A waveform is then displayed on the screen.

1

Introduction to Oscilloscopes and Probes

Figure 1.5 shows how a DSO works.

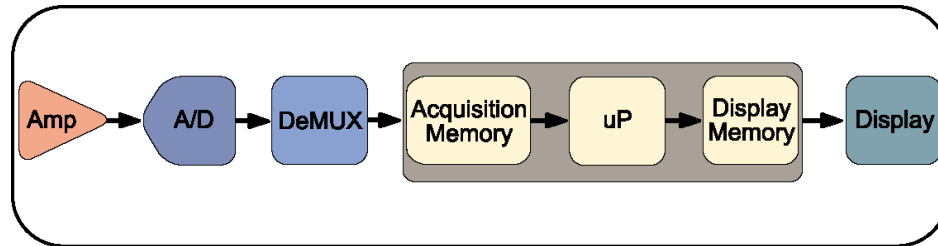

Figure 1.5: Block diagram of a DSO

A DSO contains a microprocessor (represented by uP in the figure above) that processes the signal, manages display activities, and interprets front panel controls.

Digital Phosphor Oscilloscopes

A DPO uses electronic Digital Phosphor to display waveforms on the screen. Digital Phosphor is a database that uses separate cells to store information for each pixel of the oscilloscope display screen. Every time a waveform triggers, the cells that map to the display path of the waveform are updated with intensity information. Intensity information increases in cells where the waveform passes.

When the Digital Phosphor database is loaded on the display screen of the oscilloscope, the screen shows intensified waveform areas, in proportion to the frequency of occurrence of the signal at each point. A DPO may also allow varying frequency of signal details to be displayed in different colors. Figure 1.6 shows how a DPO works.

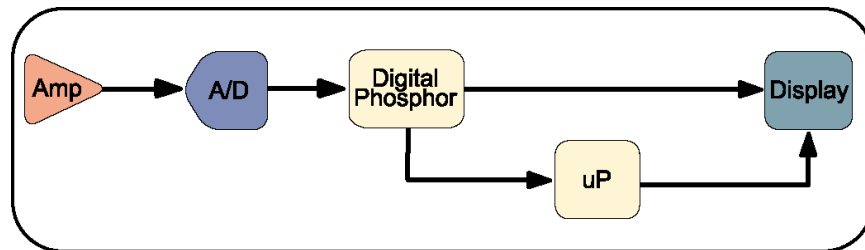

Figure 1.6: Block diagram of DPO

Similar to a DSO, a DPO also uses a microprocessor for display management, measurement automation, and analysis of the displayed waveforms.

1

Introduction to Oscilloscopes and Probes

Oscilloscope Terminology

This topic discusses the following terminology related to oscilloscopes:

- Types of waves
- Waveform measurements
- Performance terms

Types of Waves

You use waveform shapes to analyze a signal. Different types of waveforms represent different types of signals. Waveforms are classified into the following groups:

- Sine waves
- Square and rectangular waves
- Step and pulse waves
- Sawtooth and triangle waves
- Complex waves

Sine Waves

A *sine wave* is a basic waveform that represents voltage change with time. Signals produced by the oscillator circuit in a signal generator are sine waves. Most AC power sources produce sine waves. Figure 1.7 shows a sine wave.

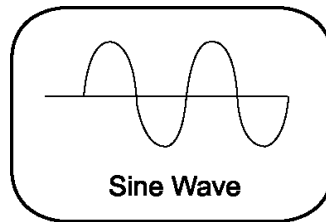

Figure 1.7: Sine wave

Square and Rectangular Waves

A *square wave* represents voltage signals that turn on and off at regular intervals. It is a standard wave for testing amplifiers, televisions, radios, and computer circuits.

A *rectangular wave* represents high and low time periods of a square wave that are unequal.

1

Introduction to Oscilloscopes and Probes

Figure 1.8 shows square and rectangular waves.

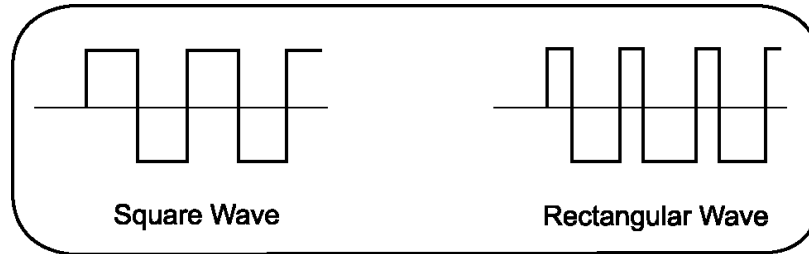

Figure 1.8: Square and rectangular waves

Step and Pulse Waves

Step and *pulse* waves are generated only once from a circuit. These signals are also called single-shot or transient signals. A *step wave* indicates a sudden change in voltage, which may be the result of turning on an electric switch. A *pulse wave* represents a sudden change in signal level followed by a return to the original level. For example, a pulse is generated if you turn a power switch on and then off again.

A pulse can represent the following information:

- One bit traveling through a computer circuit
- A defect or a glitch in a circuit

Figure 1.9 shows examples of step and pulse waves.

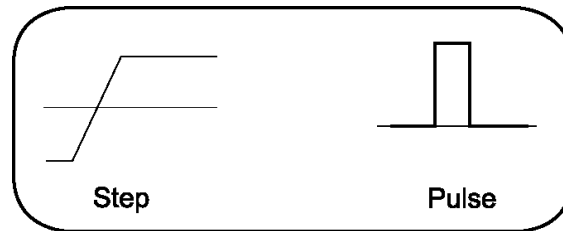

Figure 1.9: Step and pulse waves

Sawtooth and Triangle Waves

Sawtooth and *triangle* waves represent a linearly changing voltage required to control a device. A *sawtooth* wave has a rising rate of change that is different (faster or slower) than the falling rate of change. A *triangle* wave has a rising rate of change equal to the falling rate of change. Figure 1.10 shows examples of sawtooth and triangle waves.

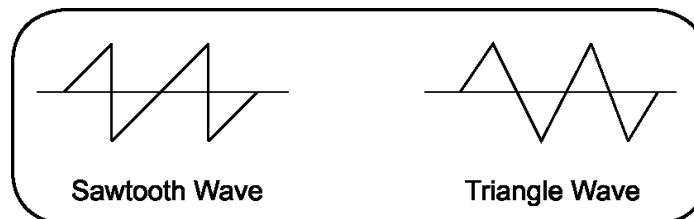

Figure 1.10: Sawtooth and triangle waves

1

Introduction to Oscilloscopes and Probes

Complex Waves

Some waveforms combine the characteristics of sines, squares, steps, and pulses to produce a *complex* wave shape. *Complex* waves can represent signal information embedded in the form of amplitude, phase, and/or frequency variations. Figure 1.11 shows a complex wave.

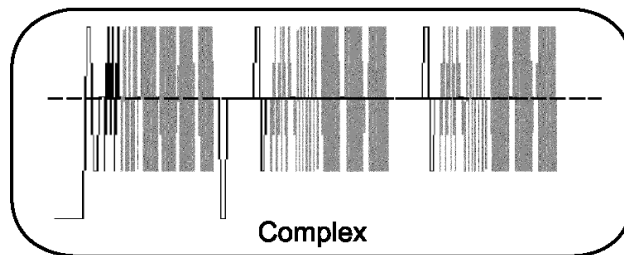

Figure 1.11: Complex wave

Waveform Measurements

You use waveform measurements to determine specific characteristics of waveforms.

Frequency and Period

Frequency represents the number of times a signal repeats itself in one second. The frequency of a signal is measured in Hertz (Hz). *Period* represents the time in which a signal completes one cycle. Figure 1.12 shows the frequency and period of a sine wave.

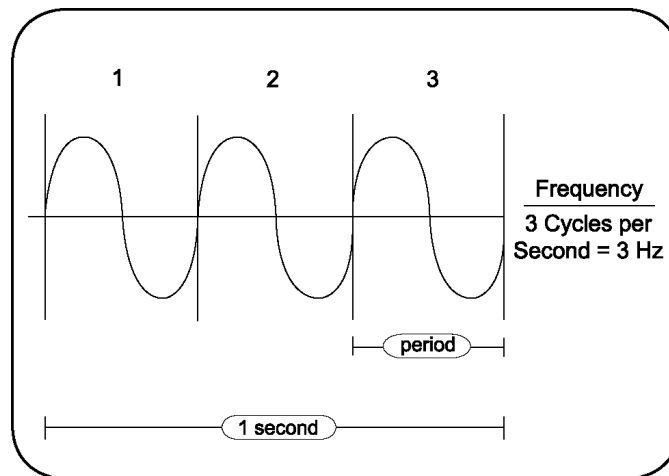

Figure 1.12: Frequency and period of a sine wave

1

Introduction to Oscilloscopes and Probes

Phase and Phase Shift

A sine wave moves through 360° in one cycle. You can use this *phase* information to calculate the elapsed time from the reference or beginning point of the sine wave.

Figure 1.13 shows phase in a sine wave.

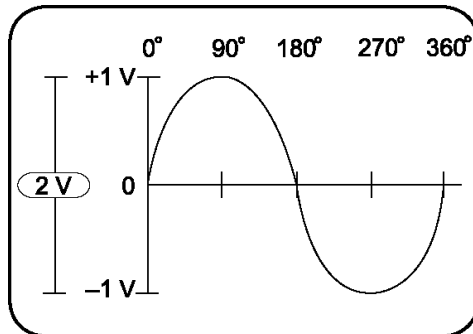

Figure 1.13: Phase in a sine wave

Phase shift refers to the degrees of difference between two similar synchronous signals. Figure 1.14 shows a phase shift between two sine waves.

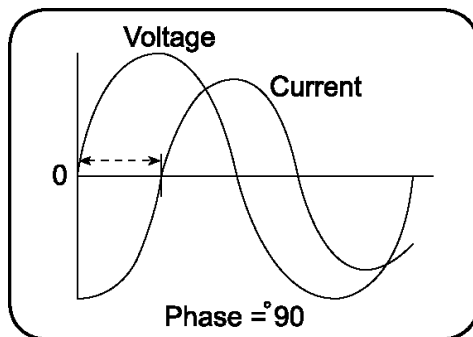

Figure 1.14: Phase shift between two sine waves

Performance Terms

Some terms and concepts related to how oscilloscopes work are discussed below.

Bandwidth

Bandwidth is the frequency range of an oscilloscope used to measure a sine wave signal accurately. By convention, bandwidth specifies the frequency at which the displayed sine wave reduces to 70.7% of the applied sine wave signal amplitude.

Rise Time

Rise time is the time taken by a step or pulse to rise from 10% to 90% amplitude level.

Vertical Sensitivity

Vertical sensitivity is the range within which an amplifier can amplify a weak signal. Vertical sensitivity is stated in volts per division (volts/div).

Sweep Speed

Sweep speed is the speed at which a waveform can sweep across the screen of an analog oscilloscope. The sweep speed of an oscilloscope is stated in time per division (sec/div).

1

Introduction to Oscilloscopes and Probes

Getting to Know Probes

This section describes the different types of probes and their applications. It includes the following topics:

- Introduction to Probes
- Types of Voltage Probes
- How Probes Affect Measurements

Introduction to Probes

A probe is an input device for an oscilloscope. You use a probe to physically connect a signal source to an oscilloscope.

A probe has two connection tips that connect the probe to a circuit element. A probe also has a cable to transmit signals from the circuit to an oscilloscope. An appropriate probe has a negligible effect on the signal transmitted to the oscilloscope and the behavior of the circuit being tested.

Types of Voltage Probes

There are two types of voltage probes. They are called passive voltage probes and active voltage probes.

Most voltage probes are packaged with standard accessories. These accessories usually include a ground lead clip that you can attach to a ground signal source, a compensation adjustment tool, and one or more probe tip accessories to help in connecting the probe to test points. Figure 1.15 shows a passive probe and standard accessories.



Figure 1.15: A passive voltage probe with accessories

1

Introduction to Oscilloscopes and Probes

Passive Voltage Probes

Passive voltage probes consist of wires, connectors, resistors, and capacitors. Passive voltage probes typically have attenuation factors of 1X, 10X, and 100X for different voltage ranges. The attenuation factor represents the number of times a probe attenuates a signal. In case of applications where signal amplitudes require the best vertical sensitivity of the oscilloscope, a 1X probe can be used. You can use a switchable 1X/10X probe for a mix of low amplitude (10mV) and moderate to high amplitude signals (10V or more).

Note: *A switchable 1X/10X passive voltage probe provides the characteristics of both 1X and 10X probes. 1X and 10X passive voltage probe modes have different characteristics regarding attenuation factors, bandwidth, rise time, and impedance. For example, a 1X passive voltage probe will present a much higher capacitive load than a 10X passive voltage probe to the circuit being tested.*

Active Voltage Probes

Active voltage probes contain active components such as transistors. Often, the active device is a field-effect transistor (FET). An active FET voltage probe can provide a very low input capacitance. As a result, active FET probes have pre-defined bandwidths ranging from 500 MHz to 4 GHz.

The high input impedance of an active FET voltage probe allows measurements to be made at test points of unknown impedance with lower risk of loading effects. As a result, active voltage probes can be used on high-impedance circuits that are sensitive to loading. On the other hand, passive voltage probes cause more loading effects, especially at high frequencies.

The voltage range of active FET voltage probes is within ± 0.6 V to ± 10 V. In addition, these probes can typically withstand a maximum voltage of ± 40 V, without being damaged. Therefore, active voltage probes are used for low signal level applications, including fast logic device families, such as ECL and GaAs.

1

Introduction to Oscilloscopes and Probes

How Probes Affect Measurements

To display a signal on an oscilloscope, the signal is diverted to the oscilloscope input circuit. Depending on the relative impedance values, the addition of the probe to the test point can cause a load. This topic describes the loading effects of probes on signals. These effects are caused by probe impedance interacting with the signal source impedance.

Signal Source Impedance

The value of the signal source impedance influences the effect of probe loading. For example, with low source impedance, a high-impedance 10X probe can have a negligible loading effect. However, for high source impedances, there can be a significant change in the signal at the test point due to the probe. This change in the signal is because the probe impedance is in parallel with the circuit impedance.

To minimize this loading effect, you can try the following remedies:

- Use a higher impedance probe.

- Measure the signal at a test point where the impedance is lower. For example, cathodes, emitters, and sources, have lower impedances than plates, collectors, and drains.

To reduce the loading effect of the probe on the signal test point, the signal amplitude that is transmitted to the oscilloscope input must be reduced, or attenuated. The attenuated signal must be manually compensated when using a high impedance passive attenuation probe.

Capacitive Loading

An increase in signal frequency or transition speed decreases the reactive impedance of a capacitive element. Consequently, *capacitive loading* increases the rise and fall times on fast transition waveforms and decreases the amplitude of high frequency details in waveforms.

1

Introduction to Oscilloscopes and Probes

When the output of a pulse generator is tested, the probe input capacitance and resistance are in parallel with the pulse generator. Probe resistance is usually ignored because it is usually much greater than the generator resistance. However, probe capacitance adds to the total load capacitance and increases the measured rise time.

Bandwidth Consideration

Bandwidth measurement system issues include the bandwidth of both the probe and the oscilloscope. Bandwidth is a sine wave specification. Bandwidth specifies the maximum frequency of a sine wave that can appear on the oscilloscope display with a maximum of 29.3% decrease in amplitude. To ensure a sine wave amplitude error of no more than 3%, the bandwidth of the oscilloscope and probe combination should be three to five times that of the circuit being tested.

Bandwidth and rise or fall time have an inverse relationship. The rise time of the probe and oscilloscope combination should be three to five times less than the rise or fall time of the measured signal. This should ensure an error of no more than 3% in the measured rise or fall time.

Summary

In this module, you learned the following:

- An oscilloscope displays a waveform that represents voltage change with time.
- Oscilloscopes are available in analog and digital types.
- Digital oscilloscopes are of two types, digital storage oscilloscopes (DSO) and digital phosphor oscilloscopes (DPO).
- A DSO uses an ADC to convert the voltage being measured into a digital format.
- A DPO uses electronic Digital Phosphor to display a waveform.
- Waveforms are classified as:
 - Sine waves
 - Square and rectangular waves
 - Step and pulse waves
 - Sawtooth and triangle waves
 - Complex waves

1

Introduction to Oscilloscopes and Probes

- You use a probe to physically connect a signal source to an oscilloscope.
- You need to compensate a passive attenuation probe to transfer an accurate signal from the circuit being tested to the oscilloscope.
- There are two types of voltage probes, active voltage probes and passive voltage probes.
- Probes affect the signal generated by a circuit by impedance loading.

2

Getting Started with TDS200 Oscilloscopes

This module introduces and describes the TDS200 series of digital storage oscilloscope. In this module, you will learn about the basic features, specifications, and primary controls of a TDS200 oscilloscope. You will also learn how to set up the oscilloscope. At the end of this module, you will be able to do the following:

- Identify the models of the TDS200 series of oscilloscopes.
- Set up a TDS200 oscilloscope for general use.
- Understand the Training 1 signal board.
- Compensate a probe.
- Identify the primary controls of a TDS200 oscilloscope.

This module includes the following sections:

- Setting Up TDS200 Oscilloscopes and Probes
- Primary Controls

Note: *TDS200 refers to all models in the TDS200 series.*

2

Getting Started with TDS200 Oscilloscopes

Setting Up TDS200 Oscilloscopes and Probes

This section provides information about the TDS200 series of oscilloscopes. In addition, this section describes the procedures to set up a TDS200 oscilloscope and the considerations that you need to keep in mind during the setup process.

This section includes the following topics:

- Introduction to TDS200 Oscilloscopes
- Setting Up TDS200 Oscilloscopes

Introduction to TDS200 Oscilloscopes

The TDS200 series of oscilloscopes consists of three models: TDS210, TDS220, and TDS224. All the models are digital real-time oscilloscopes and share various features and characteristics.

You can use the TDS200 series of oscilloscopes to perform various tasks, such as designing, debugging, verifying, and servicing circuits and manufacturing and quality control. The low cost, high performance, small size, and ease of use of these oscilloscopes make them ideal to be used for various measurement and troubleshooting applications.

Getting Started with TDS200 Oscilloscopes

Figure 2.1 shows a TDS220 oscilloscope.

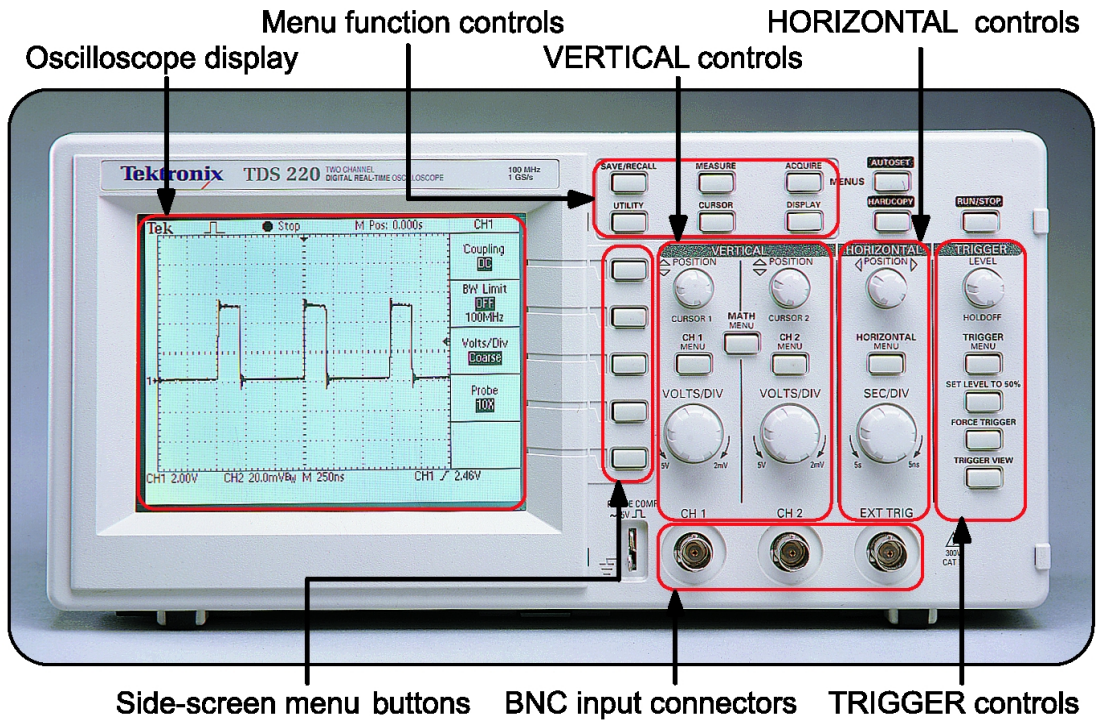

Figure 2.1: The TDS220 digital storage oscilloscope

2

Getting Started with TDS200 Oscilloscopes

Figure 2.2 shows a TDS224 oscilloscope.

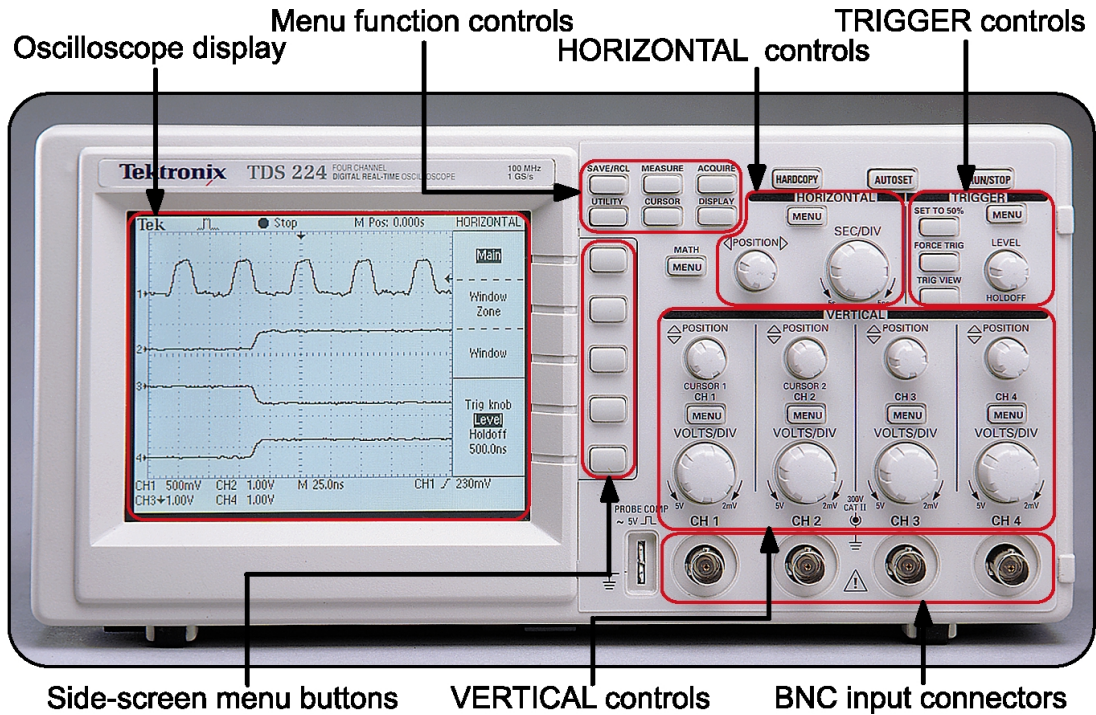

Figure 2.2: The TDS224 digital storage oscilloscope

Features of TDS200 Oscilloscopes

TDS200 oscilloscopes are versatile and flexible DSOs and provide the following features:

High bandwidth

TDS200 oscilloscopes provide a wide bandwidth that ranges from 60 MHz to 100 MHz. In addition, all the models have a bandwidth limit selection of 20 MHz.

Digital features

TDS200 oscilloscopes have a 1GS/s sample rate for every channel. All models include features, such as autoset for quick setup, automatic measurements, memory storage, and PC connectivity.

Ease of use

TDS200 oscilloscopes include a high-resolution LCD display, multi-language on-screen menus, multi-language front panel templates, separate VERTICAL controls for each channel, autoset, and automatic measurements.

2

Getting Started with TDS200 Oscilloscopes

Versatility

TDS200 oscilloscopes allow the use of various optional extension modules, such as communication and Fast Fourier Transform (FFT) modules, GPIB and LAN adapters, and waveform capture software for varied applications.

Differences Between the TDS200 Models

The various models of TDS200 oscilloscopes differ from each other primarily in bandwidth and the number of available channels. The various TDS200 models have the following basic differences:

- The TDS220 and TDS224 oscilloscopes have a bandwidth of 100 MHz while the TDS210 oscilloscope has a bandwidth of 60 MHz.

- The TDS210 and TDS220 oscilloscopes have two channels each for incoming signals while the TDS224 oscilloscope has four channels for incoming signals.
- The 2-channel TDS210 and TDS220 oscilloscopes each have an external trigger input, while the 4-channel TDS224 does not.

You will learn about other features of the three TDS200 models in the other sections of this Operator Training Kit manual.

Setting Up a TDS200 Oscilloscope

This section provides the information and procedures that you will use to set up a TDS200 oscilloscope.

Safety Precautions

You must observe certain safety precautions while setting up a TDS200 oscilloscope to avoid injury to yourself and damage to the oscilloscope.

2

Getting Started with TDS200 Oscilloscopes

The following safety precautions are to be adhered to while operating the TDS200 oscilloscope:

- Observe and understand all ratings and terminal markings on the oscilloscope before you start using it.
- Use the power cord designed for the oscilloscope. The power cord must have the appropriate power rating as per the specification in your country.
- Ensure that probes and test leads are not attached to a voltage source while connecting or disconnecting from the oscilloscope.
- Ensure that the oscilloscope is properly grounded before you connect the various accessories, such as probes, to the input or output terminals of the oscilloscope.
- Connect the probe ground lead only to the ground potential.
- Ensure that you do not operate the oscilloscope either with any panels removed or with exposed circuitry.

- Ensure that the operational environment of the oscilloscope is properly ventilated and is not humid.
- Do not connect any oscilloscope input to any AC, DC, or spike voltage over the input rating.
- Do not connect any probe input to any AC, DC, or spike voltage over the probe rating.

Preliminary Functional Check

Perform the following functional check procedure on a TDS200 oscilloscope to verify that it is functioning properly.

1. Connect your TDS200 oscilloscope to an AC supply using the appropriate power cord and adapters.
2. On the top of the oscilloscope, push the **ON/OFF** button to turn on the power.

Wait until the display shows that the oscilloscope has passed all self tests.

2

Getting Started with TDS200 Oscilloscopes

3. On the top of the front panel, push the **SAVE/RECALL** menu button.
4. Push the appropriate side-screen menu button to select **Setups**.
5. Push the appropriate side-screen menu button to select **Recall Factory**.
6. In the **VERTICAL** section, push the **CH 1 MENU** button.
7. Push the appropriate side-screen menu button to set probe attenuation for Channel 1 to **Probe 10X**.
8. Connect the P2100 passive voltage probe provided with the oscilloscope to the **CH1** input connector.

Ensure that the attenuation switch on the probe is set to **10X**.
9. Attach the probe tip and the ground lead to the **PROBE COMP** and the ground connectors on the oscilloscope, respectively.

10. On the top of the front panel, push the **AUTOSET** button.

You will observe a square wave of about 5 volts peak-to-peak at a frequency of 1 kHz, as shown in Figure 2.3.

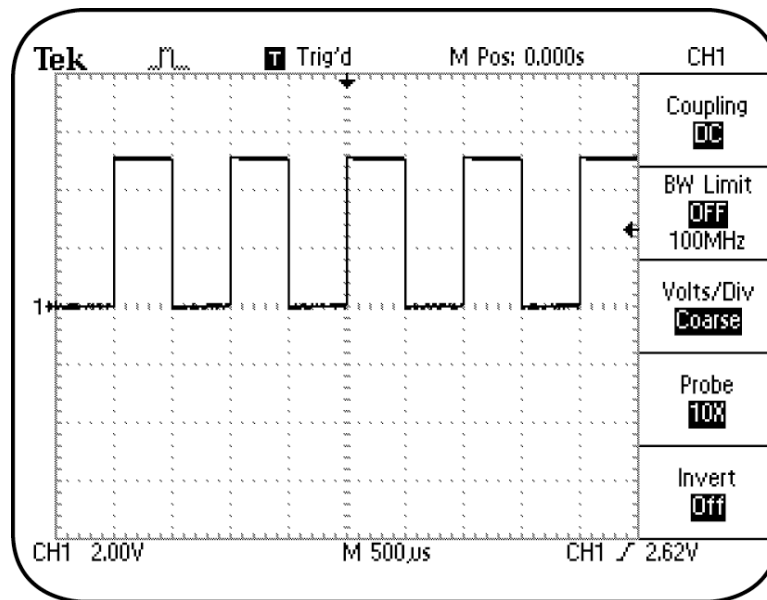

Figure 2.3: Square wave of 5 volts peak-to-peak at 1 kHz

2

Getting Started with TDS200 Oscilloscopes

11. In the **VERTICAL** section, push the **CH 1 MENU** button.
12. In the **VERTICAL** section, push the **CH 2 MENU** button and repeat steps 7 through 9 for Channel 2.

Repeat the previous procedure for Channel 3 and Channel 4 if you are using the TDS224 oscilloscope.

Your oscilloscope has passed the functional check if you observe a square wave similar to the waveform shown in Figure 2.3 for all channels.

Introduction to the Training 1 Signal Board

You will use the Training 1 signal board for most procedures in this Operator Training Kit. Figure 2.4 shows the Training 1 signal board.

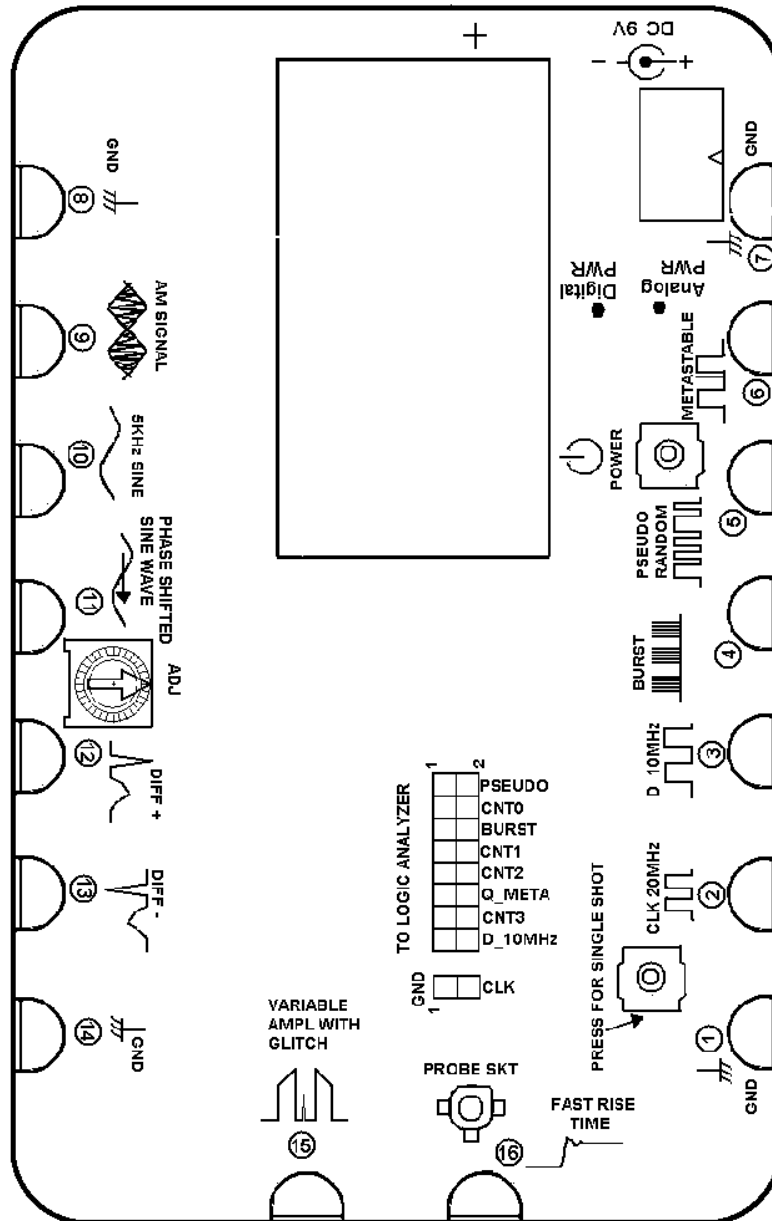

Figure 2.4: The Training 1 signal board

2

Getting Started with TDS200 Oscilloscopes

The Training 1 signal board has various pins that generate different kinds of signals. Each pin is labeled according to the signal it generates. You can view and analyze these signals on your TDS200 oscilloscope.

You can use either a 9-volt battery (NEDA type 1604, Alkaline recommended) or a line transformer with an output of 9-volts, 1A, to power the Training 1 signal board. A 9-volt battery is supplied with your Training 1 signal board. However, for long-term use you can also order the appropriate wall transformer with the recommended output for your country from Tektronix.

Part Numbers	Wall Transformer Accessories
119-4238-00	Australian plug 240V
119-4239-00	UK plug 240V
119-4240-00	Universal Euro plug 220V
119-4241-00	Japanese cert T-mark 100V
119-4242-00	U.S. plug 115V

Note: When using a wall transformer for power, you should remove the 9-volt battery from the Training 1 signal board.

You should also disconnect the wall transformer from the Training 1 signal board when the signal board is not in use. This is because even when both **Analog PWR** and **Digital PWR** indicator lights are off, wall power is still supplied to the Training 1 signal board.

The Training 1 signal board has a three-step switch. When you push **POWER** once, the analog signals of the Training 1 signal board are activated. When you push **POWER** twice, both analog and digital signals of the Training 1 signal board are activated. When you push **POWER** a third time, the Training 1 signal board is powered down.

Note: The **POWER** button does not remove all power from the Training 1 signal board. When you push the **POWER** button three times, the signal board is just put on standby.

2

Getting Started with TDS200 Oscilloscopes

Pins 1 to 6 of the Training 1 signal board provide digital signals, while pins 9 to 16 provide analog signals. All pins labeled **GND** provide the common signal reference. For a description of the signal from each pin of the Training 1 signal board, see Appendix A, *Training 1 Signal Board: Signal Definitions*, starting on page A-1.

When you use the Training 1 signal board in analog-only mode, a 9-volt battery will last for approximately thirty hours. However, when you use the Training 1 signal board in analog-digital mode, a 9-volt battery will last for approximately 7-10 hours.

The Training 1 signal board has a built in power-save mode. The Training 1 signal board switches itself off automatically after being switched on for about 1 hour.

Probe Compensation

When you attach a passive voltage attenuation probe to an oscilloscope, the capacitances of both the probe cable and the oscilloscope's input combine. This combined capacitance must match the capacitance of the input attenuation circuit of the probe. You must balance these capacitive effects between the probe and oscilloscope.

Probes are designed to match the inputs of specific oscilloscope models. However, there are slight variations between oscilloscopes and even between different input channels in an oscilloscope. To minimize these variations, attenuating passive probes (10X and 100X probes) have built-in compensation networks. You need to adjust this network to compensate the probe for the oscilloscope channel that you are using.

2

Getting Started with TDS200 Oscilloscopes

Note: *You must compensate a passive voltage attenuation probe every time you change a probe/channel connection on your oscilloscope. This ensures that the probe accurately transfers the signal from a signal source to the oscilloscope.*

The following procedure enables you to balance the capacitive and resistive effects of a probe and an oscilloscope by compensating the probe.

Note: *This procedure assumes that the oscilloscope retains the settings from the previous preliminary functional check procedure (page 2-9).*

To compensate a probe, follow these steps:

1. On the top of the front panel, push the **SAVE/RECALL** menu button.
2. Push the appropriate side-screen menu button to select **Setups**.

3. Push the appropriate side-screen menu button to select **Recall Factory**.
4. In the **VERTICAL** section, push the **CH2 MENU** button.
5. On the top of the front panel, push the **AUTOSET** button.
6. In the **VERTICAL** section, use the **VOLTS/DIV** and **POSITION** knobs for CH 1 and CH 2 to set **CH1 2.00V** in the top half of the display, and **CH2 2.00V** in the bottom half of the display.

2

Getting Started with TDS200 Oscilloscopes

You can now observe square waveforms displayed on the oscilloscope. These are similar to the waveforms shown in Figure 2.5.

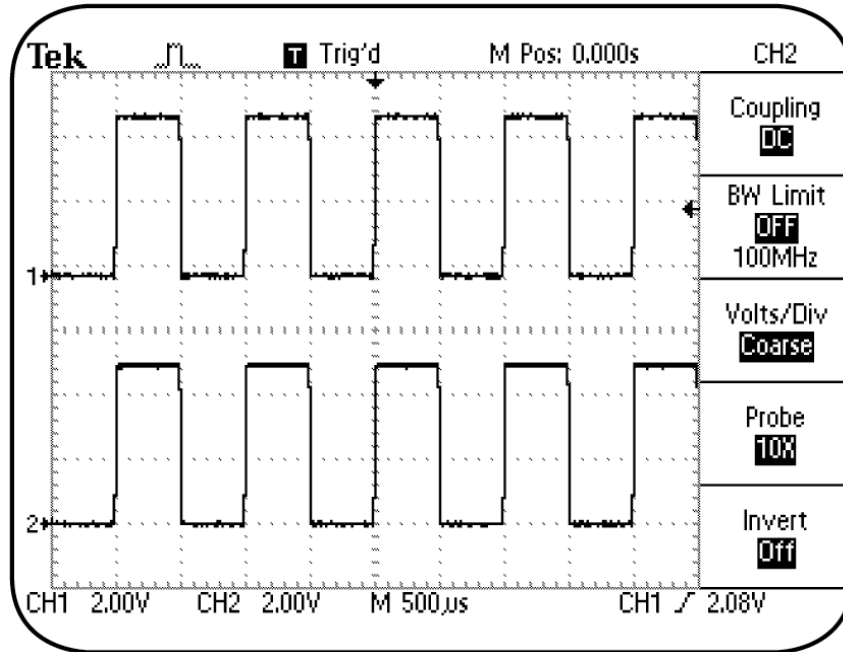

Figure 2.5: CH1 and CH2 probe compensation signal

However, the waveforms could also have distorted corners. Such waveforms could be similar to the waveforms shown in Figure 2.6 or Figure 2.7.

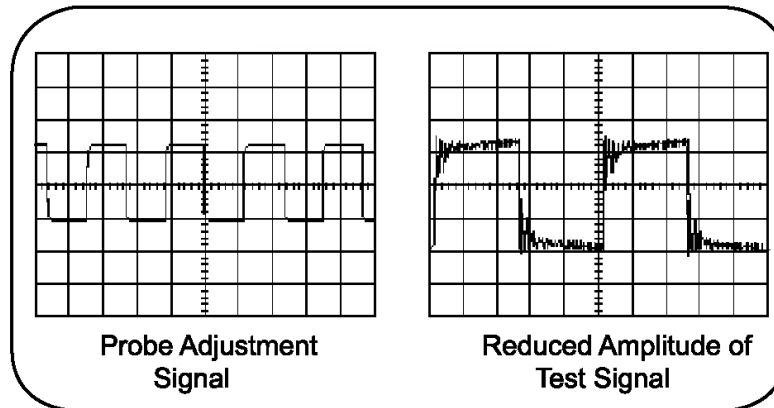

Figure 2.6: Probe undercompensated

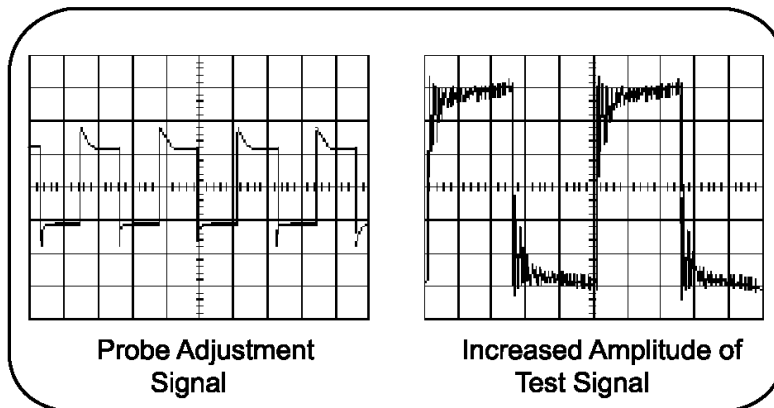

Figure 2.7: Probe overcompensated

2

Getting Started with TDS200 Oscilloscopes

An undercompensated or overcompensated probe can cause errors in measurements. To compensate the probe correctly, you must use the probe adjustment tool provided with the probe. The probe adjustment tool resembles a small screwdriver. You insert the probe adjustment tool in a small slot just behind the probe connector head in the probe body.

After probe adjustment for each channel, you should observe a square waveform with square corners as shown in Figure 2.5 on page 2-20.

Primary Controls

The TDS200 oscilloscopes provide different controls to modify different components of the displayed waveform. This section describes the following primary controls on the front panel.

- VERTICAL Controls
- HORIZONTAL Controls
- TRIGGER Controls
- Menu Function Controls

VERTICAL Controls

You use the VERTICAL controls to set or modify the waveform vertical scale, position, input coupling, bandwidth, and other signal conditioning. The VERTICAL controls consist of the following three subsections:

- VERTICAL control knobs
- VERTICAL control menu buttons
- MATH MENU controls

2

Getting Started with TDS200 Oscilloscopes

The three subsections of the VERTICAL controls are located on the front panel as shown in Figure 2.8.

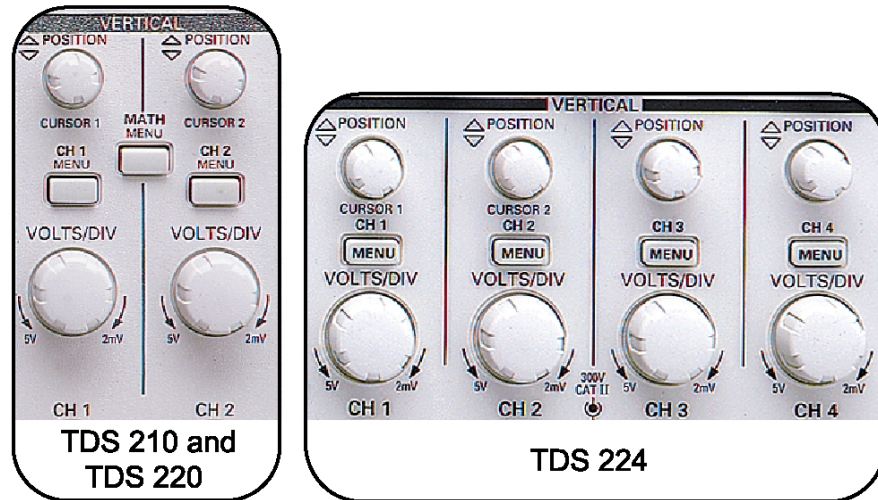

Figure 2.8: TDS200 VERTICAL controls

The TDS200 oscilloscopes have a set of VERTICAL controls for each channel.

VERTICAL Control Knobs

The VERTICAL controls for each channel consist of two knobs, the **VOLTS/DIV** knob and the **POSITION** knob.

VOLTS/DIV knob

You use the **VOLTS/DIV** knob to set and change the vertical voltage scale for the displayed waveform. For example, if the channel 1 volts/div setting is **CH1 5.00V** on the displayed readout, then each vertical division for channel 1 on the graticule represents 5 Volts, and the entire graticule of eight vertical divisions can display 40 Volts peak-to-peak.

POSITION knob

You use the **POSITION** knob of the VERTICAL controls of a given channel to move the displayed waveform up or down on the display.

2

Getting Started with TDS200 Oscilloscopes

Figure 2.9 shows the VERTICAL control knobs.



Figure 2.9: VERTICAL control knobs

VERTICAL Control Menu Buttons

A TDS200 oscilloscope includes menu-based functions to select various commands for the VERTICAL control of each channel. You use the side-screen menu-based VERTICAL controls for a channel to select various functions, such as the input coupling type, bandwidth limit of the channel, and probe attenuation.

To activate the VERTICAL menu-based functions for Channel 1, perform the following step:

- In the VERTICAL section on the front panel, push the **CH1 MENU** button.

The menu for Channel 1 is activated on the display. You can control each menu option by pushing the side-screen button next to the option. Similarly, you can activate the menu for Channel 2 for the TDS210 and TDS220 oscilloscopes. You can also select vertical menu options for Channels 3 and 4 for a TDS224 oscilloscope. Figure 2.10 shows the menu-based options for VERTICAL controls.

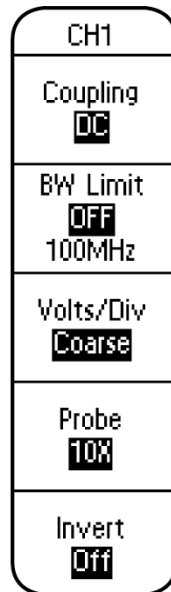

Figure 2.10: Menu-based options for VERTICAL controls

2

Getting Started with TDS200 Oscilloscopes

Menu Option	Description
Coupling	You use this menu option to select the coupling type for a channel. You can select AC , DC , or Ground .
Bandwidth Limit	You use this menu option to set the bandwidth limit of a channel at either 100 MHz for the TDS220 and TDS224 oscilloscopes (or 60 MHz for a TDS210 oscilloscope) or 20 MHz . A lower bandwidth limit lowers the displayed noise and results in a clearer display. This lowered bandwidth also limits the display of higher speed details on the selected signal.
Volts/Div	You use this menu option to select the incremental sequence of the VOLTS/DIV knob as Coarse or Fine . The Coarse option defines a 1-2-5 incremental sequence. The Fine option helps you change the resolution by small increments within the coarse settings.

Probe You use this menu option to match a probe attenuation of **1X**, **10X**, **100X**, or **1000X**.

Warning: For safety, this menu must be set correctly when working with high voltages. For example, if you have a x100 probe and this menu is set to x1, the oscilloscope will show a 2 volt signal on screen (a circuit safe to touch) when there is a 200 volt signal connected (not safe).

Invert You use this menu option to invert the displayed waveform. However, you can only use this function on a TDS210 or TDS220 oscilloscope if a TDS2MM extension module is installed. However, the **Invert** function is standard on all TDS210/220 oscilloscopes with firmware version FV:v2.00. These oscilloscopes do not require a TDS2MM module.

For procedures that use the VERTICAL controls, see *Using VERTICAL Controls* starting on page 3-1.

2

Getting Started with TDS200 Oscilloscopes

MATH MENU Controls

You use the **MATH MENU** controls to perform math operations on displayed waveforms. You can choose to add or subtract two waveforms on all TDS200 models. The FFT function is available only as an option. If the TDS2MM extension module is installed, you can perform FFT operations on a displayed waveform.

To activate the **MATH MENU** menu-based functions, perform the following step:

- In the VERTICAL section (or above the VERTICAL section for the TDS224), push the **MATH MENU** button.

The menu for the MATH operations is activated on the display.

Figure 2.11 shows the menu-based options for MATH controls. You control each menu option by pushing the side-screen button next to the option.

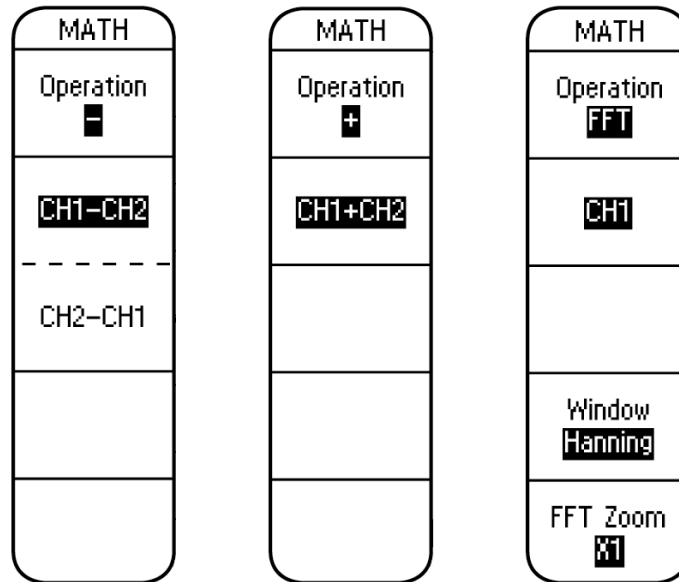

Figure 2.11: Examples of MATH MENU functions

2

Getting Started with TDS200 Oscilloscopes

Menu Options	Description
Operation	<p>You use this menu option to select the type of operation you want to perform, such as subtraction, addition, or FFT. Each operation activates a separate menu.</p> <p>The Operation menu option is not available with the TDS2MM extension module. In an oscilloscope with the TDS2MM extension module, you subtract one channel from another by inverting the subtracted channel in its menu selection.</p>
CH1+CH2	<p>This menu option is activated when you select the addition (+) operation. You use this menu option to add two waveforms from CH1 and CH2. In a TDS224 oscilloscope, you can also perform the CH3+CH4 operation.</p>

CH1-CH2 This menu option is activated when you select the subtraction (-) operation to subtract one waveform from another. You can perform both CH1-CH2 and CH2-CH1 operations. In a TDS224 oscilloscope, you can also perform CH3-CH4 and CH4-CH3 operations.

FFT This menu option is activated when you select the FFT option to perform an FFT operation on the displayed waveform. The FFT menu contains the following selections:

- Source signal as **CH1** or **CH2**.
- Window types as **Hanning**, **Rectangular**, or **Flattop**.
- FFT Zoom levels as X1, X2, X5, or X10.

For procedures using the MATH controls, see *MATH MENU Controls* starting on page 3-11.

2

Getting Started with TDS200 Oscilloscopes

HORIZONTAL Controls

You use the HORIZONTAL controls to regulate the horizontal acquisition and display of a waveform. The HORIZONTAL controls are associated with the acquisition of an input signal by the oscilloscope. You can divide the HORIZONTAL controls into the following two subsections:

- HORIZONTAL control knobs
- HORIZONTAL control menu buttons

These two sections are arranged on the front panel as shown in Figure 2.12.



Figure 2.12: TDS200 HORIZONTAL controls

HORIZONTAL Control Knobs

The HORIZONTAL control section consists of two knobs, the **SEC/DIV** knob and the **POSITION** knob.

SEC/DIV knob

You use the **SEC/DIV** knob to control a waveform's horizontal time scale. The horizontal center of the display is the time reference for expanding and compressing waveforms. If the sec/div setting is 100 milliseconds (ms), then each horizontal division on the graticule represents 100 ms and the entire graticule of 10 horizontal divisions can display 1000 ms or one second.

POSITION knob

You use the **POSITION** knob of the HORIZONTAL controls to move the displayed waveform to the left or the right of the horizontal center of the graticule. The HORIZONTAL **POSITION** knob changes the point, relative to the trigger, where the waveform appears on the screen.

2

Getting Started with TDS200 Oscilloscopes

Figure 2.13 shows the HORIZONTAL control knobs.



Figure 2.13: HORIZONTAL Control Knobs

HORIZONTAL Control Menu Buttons

A TDS200 oscilloscope includes menu-based functions to select various commands for the HORIZONTAL controls.

To activate the HORIZONTAL menu-based functions, perform the following step:

- In the HORIZONTAL section on the front panel, push the **HORIZONTAL MENU** button.

The **HORIZONTAL** menu is activated on the display. You can control each menu option by pushing the side-screen button next to the option. Figure 2.14 shows the menu-based options for HORIZONTAL controls.

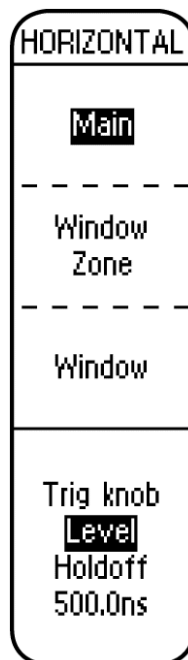

Figure 2.14: Menu-based options for HORIZONTAL controls

2

Getting Started with TDS200 Oscilloscopes

Menu Option	Description
Main	You use this menu option to display the main horizontal time base setting for the displayed waveform.
Window Zone	You use this menu option to adjust the window zone with the horizontal POSITION and SEC/DIV knobs. A window zone is an area defined by two vertical dotted line cursors on the oscilloscope display.
Window	You use this menu option to magnify the section of the waveform visible within the window zone to full horizontal screen size.
Trig knob	You use this menu option to specify whether the LEVEL/HOLDOFF knob controls the trigger level (in volts) or the trigger holdoff time (in seconds).

For procedures using the HORIZONTAL controls, see *Using HORIZONTAL Controls* starting on page 4-1.

TRIGGER Controls

You use the TRIGGER controls to reference the acquisition of signals. You also use the TRIGGER controls to set the trigger threshold conditions for a signal and assign a holdoff time to the trigger. Figure 2.15 shows the TRIGGER controls.

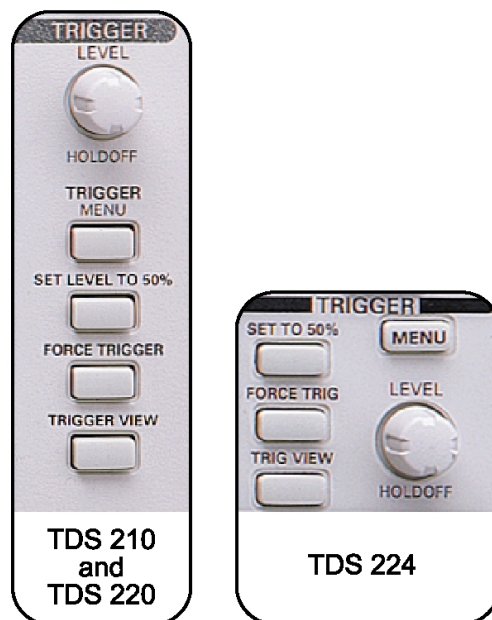

Figure 2.15: TDS200 TRIGGER controls

Warning: If the oscilloscope is incorrectly triggered, the display may not represent the signal connected to the probe. The display may instead show a previous safe reading, when a dangerous voltage is actually connected to the input.

2

Getting Started with TDS200 Oscilloscopes

The TRIGGER controls on the front panel consists of the following:

TRIGGER LEVEL/HOLDOFF knob

You use the TRIGGER **LEVEL/HOLDOFF** knob to control the trigger level or the holdoff time for a trigger. However, you must first select the appropriate option in the HORIZONTAL menu to specify whether the knob controls the trigger level or the holdoff time.

SET LEVEL TO 50% button

You use this button to set the trigger level to the vertical midpoint between the peaks of a trigger signal.

FORCE TRIGGER button

You use this button to force a signal acquisition to occur in the absence of a trigger signal. This manual trigger function can become necessary when using trigger type **Mode Normal** or **Mode Single**. You can select these trigger types from the **TRIGGER** menu.

TRIGGER VIEW button

You use this button to display the trigger waveform instead of the channel waveform. You can also use this button to check how trigger settings affect trigger signals such as trigger coupling.

You must keep the **TRIGGER VIEW** button pushed down to see the trigger waveform. The waveform disappears from the display when you release the button.

TRIGGER MENU button

You use the **TRIGGER MENU** button to activate the **TRIGGER** menu on the oscilloscope display.

To activate the TRIGGER menu-based functions, perform the following step:

- In the TRIGGER section on the front panel, push the **TRIGGER MENU** button.

The **TRIGGER** menu is activated on the display.

2

Getting Started with TDS200 Oscilloscopes

Figure 2.16 shows the menu-based options for TRIGGER controls. You can control each menu option by pushing the side-screen button next to the option.

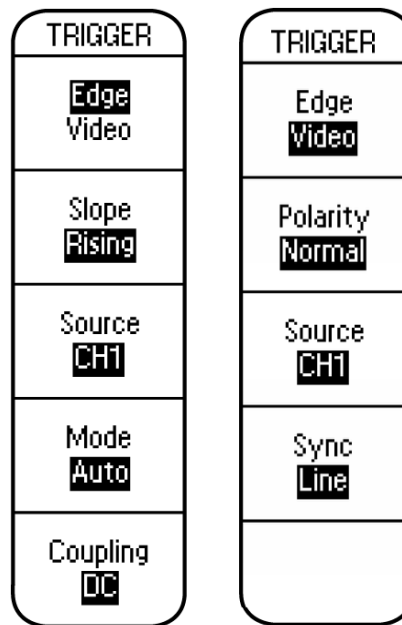

Figure 2.16: Menu-based options for TRIGGER controls

You use the **TRIGGER** menu to select either **Edge** or **Video** triggering for a waveform. Both **Edge** and **Video** triggering have a unique menu display. As a result, the menu options change according to the triggering type that you select.

You use Edge triggering to trigger on the edge of the triggering signal at the signal threshold. You can select various menu options for Edge triggering.

Menu Option	Description
Slope	You select this menu option to specify a trigger on either the rising or falling edge of a signal.
Source	You use this menu option to select an input source for a trigger signal. You can select various input sources, such as CH1 , CH2 , and AC Line , for TDS210 and TDS220 oscilloscopes. For a TDS224 oscilloscope, you can also select CH3 and CH4 as input sources.
Mode	You use this menu option to select the type of triggering as Normal , Single , or Auto . The Normal trigger mode triggers only on a valid signal.

2

Getting Started with TDS200 Oscilloscopes

The **Auto** trigger mode forces acquisitions to occur in the absence of a triggering signal. It also forces an untriggered, scanning waveform at time base settings slower than 50.0 ms.

The **Single** trigger mode is used to capture a single acquisition of a signal. In the **Single** mode, the caption **Ready** appears at the top of the oscilloscope display to indicate that the oscilloscope is ready for a trigger. You can press the **FORCE TRIGGER** button in the TRIGGER section to force an acquisition. After this trigger, the caption **Stop** appears at the top of the display. To re-arm the trigger, you need to press the **RUN/STOP** button at the top of the front panel. The caption **Ready** appears again at the top of the display.

Coupling You use this menu option to select the components of the trigger signal that are applied to the trigger circuitry. You can set the trigger coupling as **AC**, **DC**, **Noise Reject**, **HF Reject**, and **LF Reject**.

Note: For definitions of these terms, see Appendix B.

You use Video triggering to trigger on a NTSC, PAL, or SECAM standard video signal. You can select various menu options for Video triggering.

Menu Option	Description
Polarity	You use this menu option to select Normal or Inverted polarity. Inverted polarity triggers a video signal when the input signal is inverted.

2

Getting Started with TDS200 Oscilloscopes

- Source** You use this menu option to select an input source for a trigger signal. **Video** triggering uses the same input sources as **Edge** triggering.
- Sync** You use this menu option to specify whether triggering will happen on **Fields** or **Lines** of a video signal.

For procedures using the TRIGGER controls, see *Using TRIGGER Controls* starting on page 5-1.

Menu Function Controls

You use the menu function controls at the top of the front panel to perform various functions, such as saving and recalling setups and waveforms, taking automatic waveform measurements, and modifying the acquisition settings.

The menu function controls consist of six menu-based menu function buttons. When you push a menu function button, the associated menu selection options are activated on the oscilloscope screen. Figure 2.17 shows the front panel menu function controls.

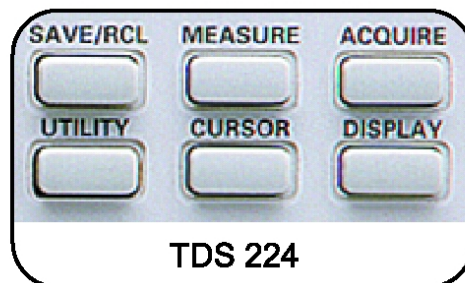
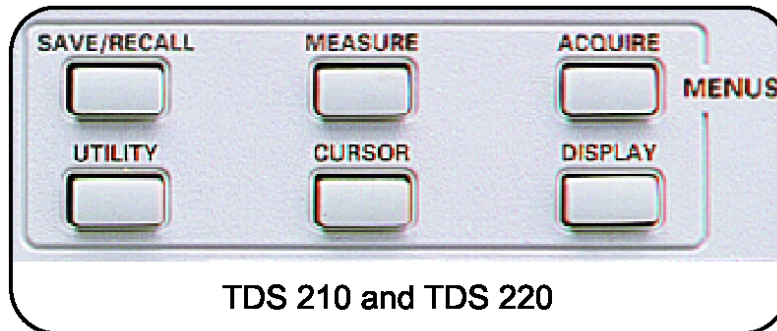

Figure 2.17: Menu function controls

2

Getting Started with TDS200 Oscilloscopes

ACQUIRE Menu Function Controls

You use the **ACQUIRE** menu function controls to regulate the signal acquisition and processing system. You can use the **ACQUIRE** menu function controls to select different types of acquisition modes for a signal.

To activate the **ACQUIRE** menu, push the **ACQUIRE** (**ACQ** on a TDS224) menu button. Figure 2.18 shows the menu-based options for the **ACQUIRE** menu function controls. You can control each menu option by pushing the side-screen button next to the option.

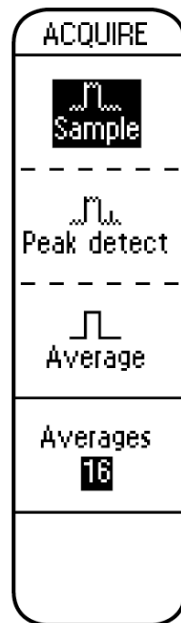

Figure 2.18: ACQUIRE menu

Menu Option	Description
Sample	You use this menu option to acquire 2500 sample points and display them at the sec/div setting. The Sample mode is the default mode for signal acquisition.
Peak detect	You use this menu option to select the Peak Detect mode for signal acquisition.
Average	You use this menu option to select the Average mode to acquire signals by taking the average of a number of unique waveforms. Averaging allows reduction of noise in the display.
Averages	You use this menu option to select the number of waveforms to average for displaying a waveform. You can choose to take the average of 4, 16, 64, or 128 waveforms.

2

Getting Started with TDS200 Oscilloscopes

For procedures using the **ACQUIRE** menu function controls, see *ACQUIRE Menu Function Controls* starting on page 6-2.

DISPLAY Menu Function Controls

You use the **DISPLAY** menu controls to select the display characteristics for waveforms. You use the **DISPLAY** menu to specify the display type, persistence, display format, and display contrast.

To activate the **DISPLAY** menu, push the **DISPLAY** menu button. Figure 2.19 shows the menu-based options for the **DISPLAY** menu function controls. You can control each menu option by pushing the side-screen menu button next to the option.

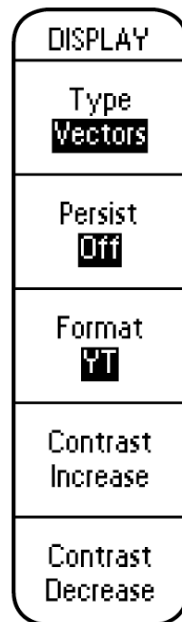

Figure 2.19: DISPLAY menu

Menu Option	Description
Type	You use this menu option to specify whether the waveform will be displayed in dots or vectors.
Persist	You use this menu option to specify the duration for which each sample point is displayed.
Format	You use this menu option to specify whether the waveform is displayed in the YT format or in the XY format. The <i>YT format</i> displays the changes in voltage with relation to time. The <i>XY format</i> displays CH1 and CH2 on the horizontal and vertical axis, respectively.

2

Getting Started with TDS200 Oscilloscopes

Contrast Increase You use this menu option to increase the display contrast.

Contrast Decrease You use this menu option to decrease the display contrast.

For procedures using the **DISPLAY** menu function controls, see *DISPLAY Menu Function Controls* starting on page 6-15

CURSOR Menu Function Controls

You use the **CURSOR** menu function controls to make parametric amplitude and time measurements on a selected waveform.

To activate the **CURSOR** menu, push the **CURSOR** menu button.

Figure 2.20 shows the menu-based options for the **CURSOR** menu function controls. You control each menu option by pushing the side-screen button next to the option.

CURSOR	CURSOR
Type Time	Type Voltage
Source CH1	Source CH1
Delta 520.0.us 1.923kHz	Delta 5.36V
Cursor 1 -1.020ms	Cursor 1 -80.0mV
Cursor 2 -500.0.us	Cursor 2 5.28V

Figure 2.20: CURSOR menu

2

Getting Started with TDS200 Oscilloscopes

Menu Option	Description
Type	You use this menu option to specify cursor measurements of Voltage (signal amplitude) or Time .
Source	You use this menu option to choose different cursor signal sources, such as CH1 , CH2 , MATH , Ref A , or Ref B , for a displayed waveform on TDS210 and TDS220 oscilloscopes. CH3 , CH4 , RefC , and RefD are also available on a TDS224 oscilloscope.
Delta	This menu option displays the difference between the readings of two cursors.

Cursor 1 and **Cursor 2** These menu options display the voltage or time locations of Cursor 1 and Cursor 2. You reference time to the trigger position and voltage to ground.

Note: *Cursor selections are not available for DISPLAY Format XY.*

For procedures using the **CURSOR** menu function controls, see *CURSOR Menu Function Controls* starting on page 6-24.

2

Getting Started with TDS200 Oscilloscopes

MEASURE Menu Function Controls

The **MEASURE** menu function controls allow you to take pre-defined automated measurements of waveforms.

To activate the **MEASURE** menu, push the **MEASURE** menu button. Figure 2.21 shows the menu-based options for the **MEASURE** menu function controls for **Type**. You can control each menu option by pushing the side-screen button next to the option.

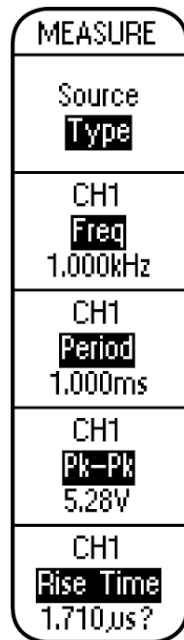

Figure 2.21: MEASURE menu for Type

Menu Option	Description
Source	You use this menu option to specify the source of a waveform as CH1 or CH2 for TDS210 and TDS220 oscilloscopes. CH3 and CH4 are also available on a TDS224 oscilloscope. You can display up to four measurements at a time.
Type	You use this menu option to specify the type of measurement to be made for each source selection. You can select from nine types of measurements for each of the four possible source selections. For example, you can make measurements of the frequency, period, and rise time (available only when a TDS2MM extension module is installed) of a waveform.

For procedures using the **MEASURE** menu function controls, see *MEASURE Menu Function Controls* starting on page 6-36.

2

Getting Started with TDS200 Oscilloscopes

SAVE/RECALL Menu Function Controls

You use the **SAVE/RECALL** (**SAVE/RCL** on the TDS224 oscilloscope) menu function controls to save and recall up to five oscilloscope setups or two waveforms (four waveforms on the TDS224 oscilloscope). You can also use the **SAVE/RECALL** menu function controls to recall the default factory settings.

To activate the **SAVE/RECALL** menu, push the **SAVE/RECALL** menu button. Figure 2.22 shows the menu-based options for the **SAVE/RECALL** menu function controls. You can control each menu option by pushing the side-screen menu button next to the option.

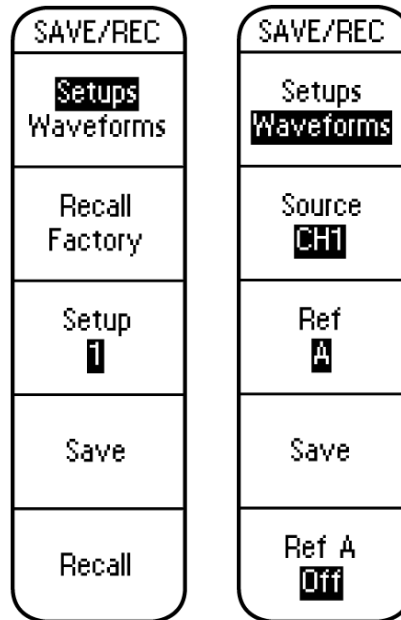

Figure 2.22: SAVE/RECALL menu

You can use the **SAVE/RECALL** menu to select either **Setups** or **Waveforms**. Both **Setups** and **Waveforms** have a unique menu display. In other words, each option activates a menu of its own.

If you select **Setups**, you can select various menu options to save and recall instrument setups.

Menu Option	Description
Recall Factory	You use this menu option to restore the oscilloscope to the factory settings.
Setup	You use this menu option to specify any of the five memory locations to save or recall a setup.
Save	You use this menu option to save the existing operational setup to a selected memory location.
Recall	You use this menu option to recall a specific saved setup.

2

Getting Started with TDS200 Oscilloscopes

If you select **Waveforms**, you can select various menu options to save and recall waveforms.

Menu Option	Description
Source	You use this menu option to select the signal source as CH1 , CH2 , or MATH in TDS210 and TDS220 oscilloscopes. You can also select CH3 and CH4 as the signal source in a TDS224 oscilloscope.
Ref	You use this menu option to select the reference locations to save or recall a waveform. The TDS210 and TDS220 oscilloscopes have Ref A and Ref B as reference locations while the TDS224 oscilloscope also has Ref C and Ref D .
Save	You use this menu option to save any channel or math waveform to the specified Ref memory location.

Ref (x) You use this menu option to turn the selected **Ref** waveform display on or off.

For procedures using the **SAVE/RECALL** menu function controls, see *SAVE/RECALL Menu Function Controls* starting on page 6-39.

UTILITY Menu Function Controls

You use the **UTILITY** menu function controls to access the various oscilloscope setup utility functions. You can use the **UTILITY** menu function controls to check the system status, set up hard copy and communication utilities, perform self-calibration for the oscilloscope, and change the language of the side-screen menu.

To activate the **UTILITY** menu, push the **UTILITY** menu button.

2

Getting Started with TDS200 Oscilloscopes

Figure 2.23 shows the menu-based options for the **UTILITY** menu function controls. You can control each menu option by pushing the side-screen menu button next to the option.

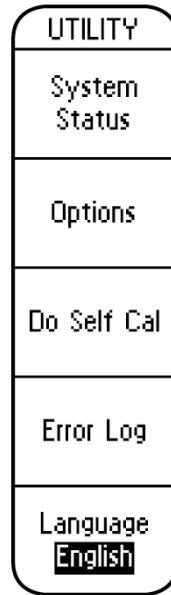

Figure 2.23: UTILITY menu

Menu Option	Description
System Status	You use this menu option to check the system status with respect to the VERTICAL, HORIZONTAL, and TRIGGER controls.

- Options** You use this menu option to set up the printing and communication utilities. However, you must have the TDS2MM or TDS2CM extension module installed to use the Hard Copy, RS232, and GPIB setup utilities.
- Do Self Cal** You use this menu option to enable a TDS200 oscilloscope to perform self-calibration.
- Error Log** You use this option to view the error log generated during signal measurements.
- Language** You use this menu option to select the display language for the side screen menu from the various available options, which are English, French, German, Italian, Spanish, Portuguese, Chinese, Simplified Chinese, Japanese, and Korean.

For a procedure using the **UTILITY** menu function controls, see *UTILITY Menu Function Controls* starting on page 6-46.

2

Getting Started with TDS200 Oscilloscopes

Summary

In this module, you learned about the following:

- Basic features of TDS200 series oscilloscopes.
- Differences between the various models of the oscilloscopes.
- Set up procedure for the oscilloscope.
- Probe compensation procedure.
- Layout, features, and controls of the primary sections of the oscilloscope.

3

Using VERTICAL Controls

You have learned about the various front panel controls. This module focuses on the VERTICAL and MATH MENU controls on the front panel. You will use various procedures to modify the displayed waveform by using the VERTICAL and MATH MENU controls.

This module includes the following sections:

- VERTICAL Control Knobs
- VERTICAL Control Menu Buttons
- MATH MENU Controls

3

Using VERTICAL Controls

VERTICAL Control Knobs

The VERTICAL control section for each channel has two knobs, **VOLTS/DIV** and **POSITION**.

VOLTS/DIV knob

You use the **VOLTS/DIV** knob of a given channel to modify the calibration of the vertical scale of the channel. In other words, the **VOLTS/DIV** knob allows you to increase or decrease the vertical resolution of a displayed waveform.

POSITION knob

You use the **POSITION** knob to vertically position a waveform on the display.

Figure 3.1 shows the VERTICAL control section of TDS200 series of oscilloscopes.

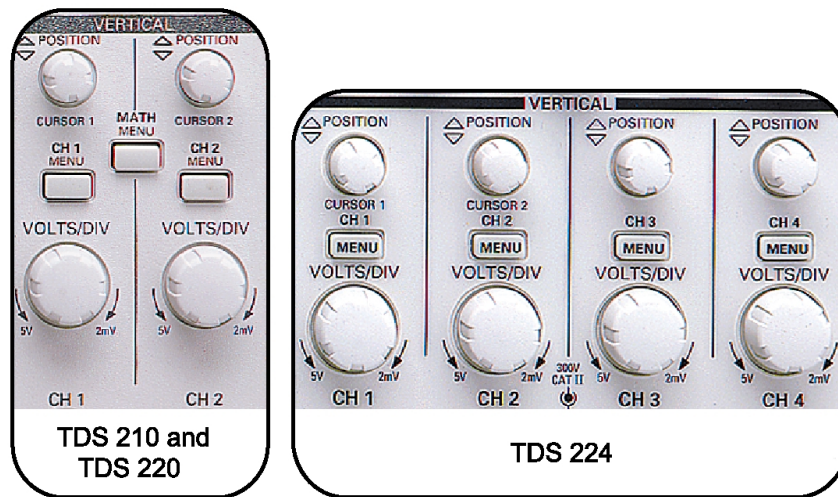

Figure 3.1: TDS200 VERTICAL control section

Setting Up VERTICAL Controls

Before you use the VERTICAL controls, you must ensure that the oscilloscope is set up for the VERTICAL controls.

The following procedure sets up a TDS200 oscilloscope for VERTICAL controls.

To set up a TDS200 oscilloscope for the VERTICAL controls, follow these steps:

1. Connect two P2100 probes to the **CH1** and **CH2** BNC input connectors on the front panel.
2. Connect the CH1 and CH2 probe tips to the **PROBE COMP** signal on the front panel, and connect the CH1 and CH2 ground leads to the ground reference pin directly below the **PROBE COMP** pin.
3. On the top of the front panel, push the **SAVE/RECALL** menu button.
4. Push the appropriate side-screen menu button to select **Setups**.
5. Push the appropriate side-screen menu button to select **Recall Factory**.

3

Using VERTICAL Controls

6. In the VERTICAL section, push the **CH 2 MENU** button.
7. On the top of the front panel, push the **AUTOSET** button.
8. In the **VERTICAL** section, turn the **VOLTS/DIV** and **POSITION** knobs for CH 1 and CH 2 to set **CH1 2.00V** in the top half of the display, and **CH2 2.00V** in the bottom half of the display.

You will see waveforms similar to those shown in Figure 3.2. Figure 3.2 shows a square waveform for both CH 1 and CH 2.

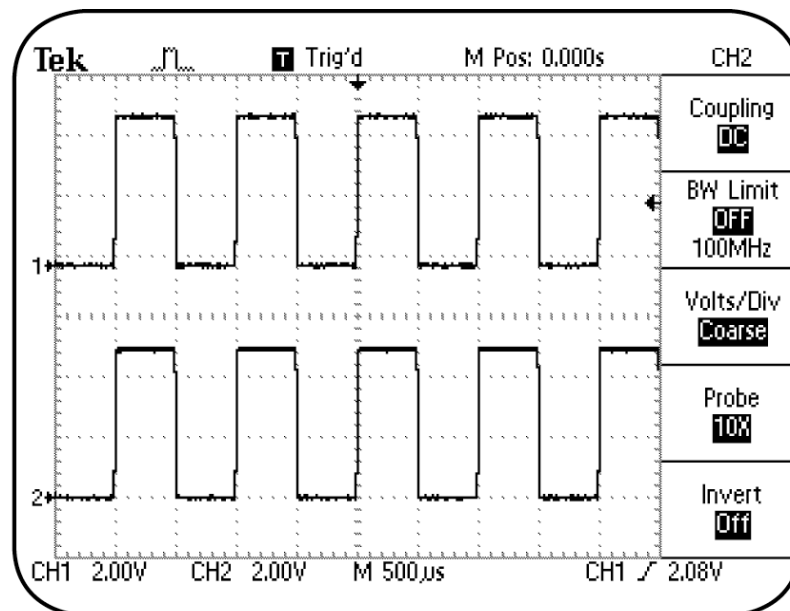

Figure 3.2: VERTICAL setup

After you set up your oscilloscope for VERTICAL controls, you can perform various procedures, such as switching the input coupling of a signal, modifying the vertical scale, and changing the vertical position of a waveform.

Switching the Input Coupling

Coupling is the method you use to connect an electrical signal from one device to another. For example, you implement input coupling when you connect the Training 1 signal board to an oscilloscope. You can select AC, DC, or Ground coupling on the oscilloscope. The oscilloscope uses coupling to display components of a waveform in the following ways:

- *AC coupling* blocks the DC component of a signal and displays only the AC component of the waveform, centered around zero volts.
- *DC coupling* displays the entire signal.
- *Ground coupling* disconnects the signal from the vertical scale and displays a horizontal line at zero volts.

3

Using VERTICAL Controls

You can change the type of input coupling to view the various components of a signal. For example, you can use vertical AC coupling to view a repeating signal that is above 10 Hz and has a large DC offset. AC coupling allows you to view such signals without any special offset controls.

The following procedure enables you to view how different input coupling settings affect the displayed waveform.

***Note:** This procedure assumes that the oscilloscope retains the settings from the previous procedure.*

To switch between AC and DC coupling, follow these steps:

1. In the VERTICAL section, push the **CH 2 MENU** button to turn off the display for Channel 2.
2. Push the **CH 1 MENU** button to activate the CH 1 menu.
3. Push the appropriate side-screen menu button to select **Coupling AC**.

The waveform shifts down because AC coupling blocks the DC component of the signal.

However, the ground reference arrow and the trigger level reference arrow at the left and right of the display, respectively, do not shift from their initial positions.

4. In the **VERTICAL** section, turn the **Channel 1 VOLTS/DIV** knob clockwise to set the CH 1 vertical scale readout at the bottom left corner of the oscilloscope display to be **50.0mV**.
5. Turn the **Channel 1 POSITION** knob clockwise to set the vertical position at **50.00 divs (2.50V)**. Fine-tune the probe calibration for a square waveform.

Notice that the bottom of the magnified AC coupled signal is now visible. This is possible with 50 vertical divisions of position offset.

6. Push the appropriate side-screen menu button to select **Coupling DC**.
7. Turn the **Channel 1 POSITION** knob counter-clockwise to set the vertical position at **0.00 divs (0.00V)**.

Notice that the flatness of the probe compensation waveform changes when you switch from AC coupling to DC coupling.

3

Using VERTICAL Controls

This happens because AC coupling is a high pass filter that blocks a component of the signal.

8. Turn the **Channel 1 POSITION** knob counter-clockwise to set the vertical position **at -100.00 divs (-5.00V)**. Re-calibrate the probe for a square waveform.

You can see the positive peaks of the waveform with 100 divisions of position offset, as shown in Figure 3.3. This allows you to analyze details on the signal that would otherwise not be visible.

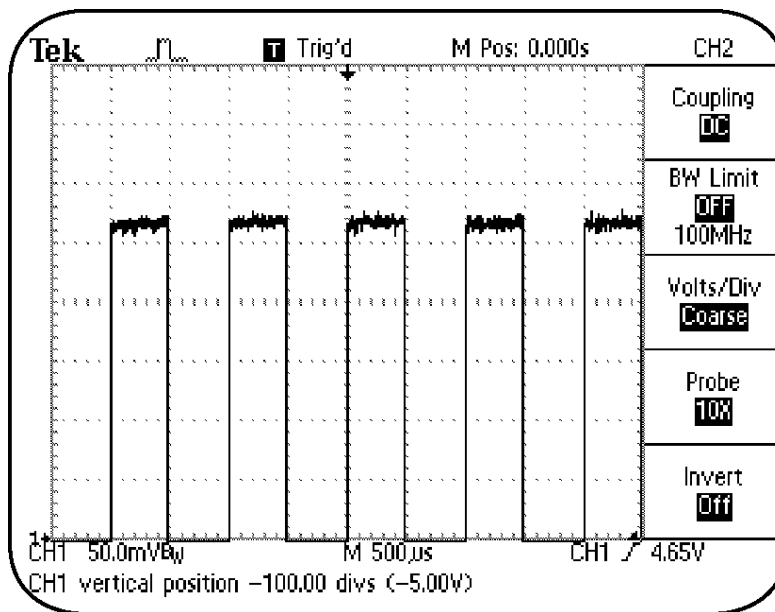

Figure 3.3: Vertical display, with 100 divisions of offset

VERTICAL Control MENU Buttons

You use the various side-screen menu buttons of VERTICAL controls to select special functions, such as the input coupling for the signal, the bandwidth limit of the oscilloscope, and the probe attenuation factor. The next procedure demonstrates the steps to use the side-screen menu buttons of VERTICAL controls to modify the vertical scale of a waveform.

Modifying the Vertical Scale of a Displayed Waveform

You use the **VOLTS/DIV** knob to increase or decrease the vertical resolution of the display. This enables you to view the displayed waveform in detail.

The following procedure enables you to view the vertical component of a displayed waveform in fine detail by modifying its vertical scale.

Note: *This procedure assumes that the oscilloscope retains the settings from the previous procedure.*

To modify the vertical scale of a displayed waveform, follow these steps:

1. On the top of the front panel, push the **AUTOSET** button.

3

Using VERTICAL Controls

2. Push the appropriate side-screen menu button to select **Probe 10X** for Channel 1.
3. Push the appropriate side-screen menu button to select **BW Limit ON 20MHz**.

Limiting the bandwidth of the oscilloscope reduces high-frequency noise in the waveform.

4. Push the appropriate side-screen menu button to select **Volts/Div Fine**.
5. In the **VERTICAL** section, turn the **Channel 1 VOLTS/DIV** knob to modify the vertical volts/division scale.

You can now modify the vertical scale of a waveform with a higher resolution. Notice that the CH1 scale at the bottom left of the display changes in fine increments.

Note: For information on safe input voltage, see warning on page 2-29.

MATH MENU Controls

You use the **MATH MENU** controls to perform math operations, such as addition and subtraction of waveforms. For example, you can measure the difference in voltage between two points in a circuit by subtracting one waveform from another. In addition, you can use the **MATH MENU** controls to perform Fast Fourier Transform (FFT) operations on a waveform.

***Note:** The operating control details of the MATH function in the TDS200 oscilloscopes varies according to the model number and the option configuration. Refer to your TDS200 User Manual for details.*

Adding Two Waveforms

You can use the oscilloscope to add two waveforms. For example, you may need to analyze whether an adder circuit is working properly, or if the positive and negative voltage swings of a differential pair are equal and opposite.

The following procedure enables you to add waveforms to verify the operation of a circuit that adds or subtracts signals.

3

Using VERTICAL Controls

To add waveforms from two channels, follow these steps:

1. On the top of the front panel, push the **SAVE/RECALL** menu button.
2. Push the appropriate side-screen menu button to select **Setups**.
3. Push the appropriate side-screen menu button to select **Recall Factory**.
4. In the **VERTICAL** section, push the **CH2 MENU** button.
5. On the top of the front panel, push the **AUTOSET** button.
6. In the **VERTICAL** section, push the **MATH MENU** button.
7. Push the appropriate side-screen menu button to select **Operation +**.

Your TDS200 oscilloscope may not have this menu option. In this case, you will not need to make this selection for this demonstration procedure.

8. Push the appropriate side-screen menu button to select **CH1+CH2**.

You will see waveforms similar to those shown in Figure 3.4. The displayed waveform adjacent to the **M** icon at the left of the display is the sum of the waveforms of CH1 and CH2. The **M** icon indicates the MATH waveform.

Note: Depending on the model of TDS200 oscilloscope that you use, you may see only the MATH waveform. If you see the channel waveforms, you can remove them from the display by pushing the **CH 1 MENU** and the **CH 2 MENU** buttons once or twice.

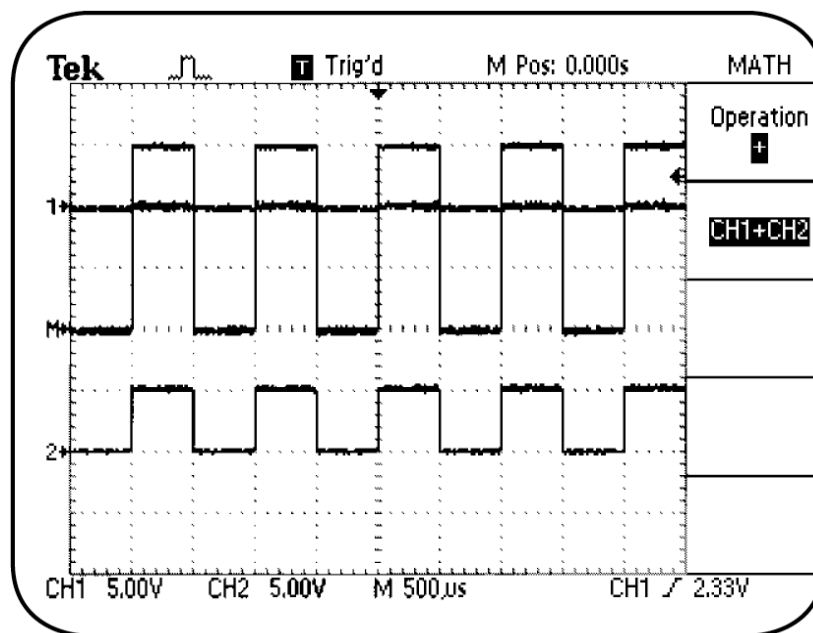

Figure 3.4: Vertical display, CH1+CH2

3

Using VERTICAL Controls

Subtracting Two Waveforms

You can use the oscilloscope to subtract two waveforms to isolate and view the differential of the two signals, while rejecting common mode signals. For example, consider a situation where you need to evaluate a switching power supply FET with respect to switching time and load regulation effects. You can measure the signals at the source and drain of the switching transistor and then subtract these two waveforms to measure the differential signal.

The following procedure shows how to use the MATH functions to obtain the differential of two waveforms.

To obtain the differential of the two waveforms, follow these steps:

1. Connect the CH 1 probe tip to the **DIFF +** signal on pin 12 and the CH1 ground lead to **GND** on pin 8 of the Training 1 signal board.
2. Connect the CH 2 probe tip to the **DIFF –** signal on pin 13 and the CH2 ground lead to **GND** on pin 14 of the Training 1 signal board.

3. On the Training 1 signal board, push the **POWER** button until only the **Analog PWR** light is on.
4. On the top of the front panel, push the **SAVE/RECALL** menu button.
5. Push the appropriate side-screen menu button to select **Setups**.
6. Push the appropriate side-screen menu button to select **Recall Factory**.
7. In the VERTICAL section, push the **CH 2 MENU** button.
8. In the VERTICAL section, turn the **CH1** and **CH2 VOLTS/DIV** knobs to set both channels for **500mV** at the bottom of the display.

3

Using VERTICAL Controls

9. In the HORIZONTAL section, turn the **SEC/DIV** knob counterclockwise to set the time base displayed at the bottom of the oscilloscope display as **M 250 ms**.

Note that the CH1 and CH2 waveforms are displayed as sine shaped waveforms scanning the screen, overlaying each other.

10. Push the appropriate side-screen menu button to select **Invert On** for channel 2.
11. In the VERTICAL section, push the **MATH MENU** button.
12. Push the appropriate side-screen menu button to select **Operation +**.

Your oscilloscope may not have this menu option. In this case, you will not need to make this selection for this demonstration procedure.

13. Push the appropriate side-screen menu button to select **CH1+CH2**.

You will see waveforms similar to those shown in Figure 3.5.

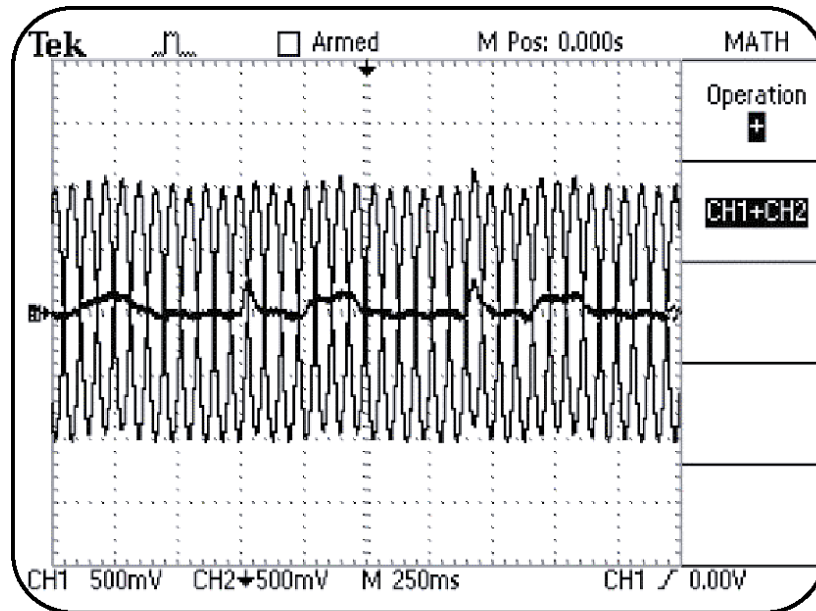

Figure 3.5: Vertical display of CH1-CH2

Note that a slow 'heart beat' signal is differentially buried in the large common mode sine wave signal that is on both Channel 1 and Channel 2.

3

Using VERTICAL Controls

Note: Depending on the model of TDS200 oscilloscope that you use, you may see only the MATH waveform. If you see the channel waveforms, you can remove them from the display by pushing the **CH 1 MENU** and the **CH 2 MENU** buttons once or twice.

Performing FFT Operations

FFT is an algorithm used to transform time-domain information to frequency domain information. You use FFT operations in an oscilloscope to view and measure repeating complex waves as sine wave components. For example, you can use FFT for radio frequency analysis of radio transmitters, as well as for vibration analysis of mechanical devices.

This procedure will enable you to view and analyze a repeating waveform as sine wave components by performing an FFT operation on this waveform.

Note: This procedure assumes that you have the TDS2MM extension module installed on your TDS200 oscilloscope.

To perform an FFT operation using the **MATH MENU** button of the VERTICAL controls, follow these steps:

1. Connect the **CH1** probe tip to the **PROBE COMP** pin and the CH1 ground lead to the ground reference pin directly below the **PROBE COMP** pin on the front panel.
2. On the top of the front panel, push the **SAVE/RECALL** menu button.
3. Push the appropriate side-screen menu button to select **Setups**.
4. Push the appropriate side-screen menu button to select **Recall Factory**.
5. On the top of the front panel, push the **AUTOSET** button.
6. In the VERTICAL section, push the **MATH MENU** button.

3

Using VERTICAL Controls

7. Push the appropriate side-screen menu button to select **FFT CH1**.
8. In the HORIZONTAL section, turn the **SEC/DIV** knob counter-clockwise to set the frequency scale at **5.00 kHz**.
9. Turn the **HORIZONTAL POSITION** knob clockwise to position the beginning of the frequency domain display four divisions from the left of the display.
10. Push the appropriate side-screen menu button to select the **FFT Zoom X5** option.

The displayed FFT waveform displays the harmonic content of the calibrator signal.

You can observe both the odd and even harmonics of the 1 kHz frequency, as shown in Figure 3.6.

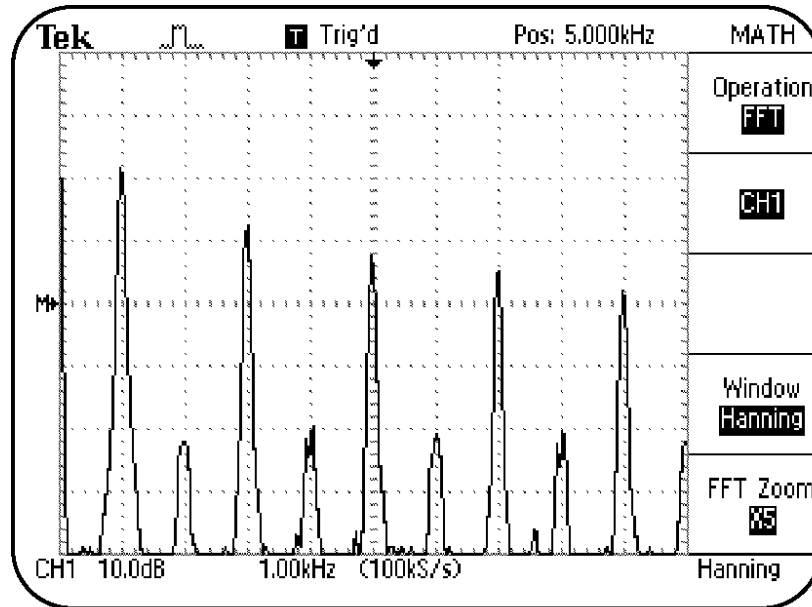

Figure 3.6: FFT display of the calibrator signal

3

Using VERTICAL Controls

Summary

In this module, you learned to perform the following tasks:

- Use the VERTICAL **VOLTS/DIV** knob controls to modify the calibration of the vertical scale of the display.
- Use the VERTICAL **POSITION** knob controls to position a waveform on the vertical scale of the display.
- Switch the input coupling type from AC to DC.
- Use AC coupling to view a repeating signal with a large DC offset.
- Use the VERTICAL **MENU** controls to select special functions, such as changing the bandwidth limit of the oscilloscope to view the waveform with less noise interference.
- Use **MATH MENU** controls to perform addition, subtraction, and FFT operations on waveforms.

4

Using HORIZONTAL Controls

In the previous module, you learned to use the VERTICAL controls on the front panel. This module focuses on the HORIZONTAL controls on the front panel. In this module, you will learn various procedures to modify a displayed waveform by using HORIZONTAL controls.

This module includes the following sections:

- HORIZONTAL Control Knobs
- HORIZONTAL Control MENU Buttons

4

Using HORIZONTAL Controls

HORIZONTAL Control Knobs

The HORIZONTAL control section consists of two knobs, the **SEC/DIV** knob and the **POSITION** knob.

SEC/DIV knob

You use the **SEC/DIV** knob to modify the horizontal time scale of a displayed waveform. You can also use the **SEC/DIV** knob to increase or decrease the horizontal resolution of a displayed waveform.

POSITION knob

You use the HORIZONTAL **POSITION** knob to position a waveform horizontally on the oscilloscope display.

Figure 4.1 shows the HORIZONTAL control sections on the front panel.



Figure 4.1: HORIZONTAL control sections

4

Using HORIZONTAL Controls

Setting Up HORIZONTAL Controls

Before you use the HORIZONTAL controls, you need to set the oscilloscope to its default setting.

Note: *It is assumed that the Channel 1 probe is connected to the **PROBE COMP** signal on the front panel.*

To set up a TDS200 oscilloscope for the HORIZONTAL controls, follow these steps:

1. On the top of the front panel, push the **SAVE/RECALL** menu button.
2. Push the appropriate side-screen menu button to select **Recall Factory**.
3. On the top of the front panel, push the **AUTOSET** button.

You will see a waveform similar to that shown in Figure 4.2.

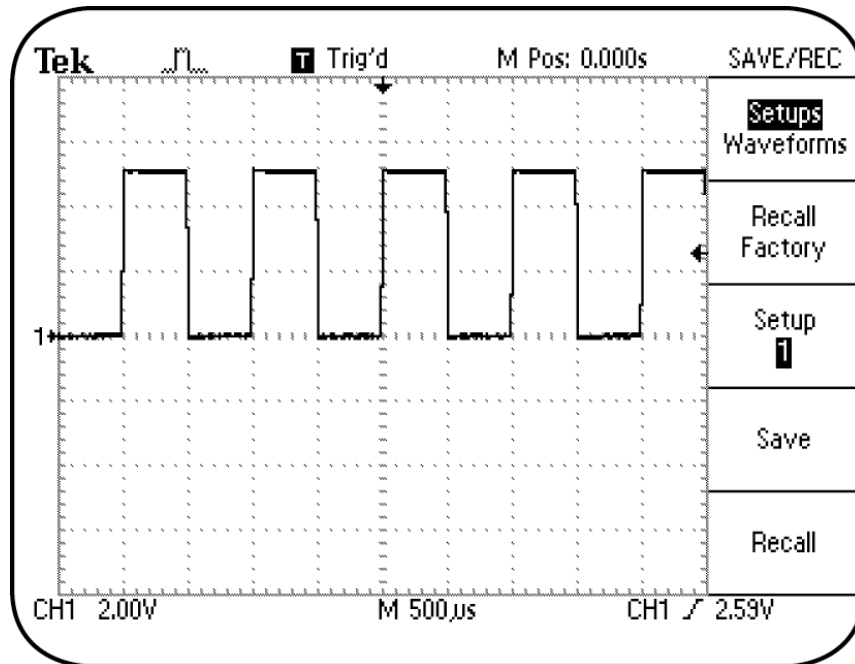

Figure 4.2: TDS200 HORIZONTAL setup

After you set up the oscilloscope for HORIZONTAL controls, you can perform various procedures, such as setting the delay time for a waveform.

4

Using HORIZONTAL Controls

Setting the Delay Time for a Waveform

You can change the delay time for a displayed waveform by changing the trigger position for the waveform.

Setting a delay time for a waveform allows you to see an expanded view of the waveform at different time positions from the trigger position.

The following procedure enables you to set a delay time for a displayed waveform by changing the horizontal position of the trigger.

***Note:** This procedure assumes that the oscilloscope retains the settings from the previous procedure.*

To set the delay time for a displayed waveform, follow these steps:

1. In the HORIZONTAL section, turn the **SEC/DIV** knob counter-clockwise to set the time base readout at the bottom of the display to **M 5.00ms**.

- Turn the **HORIZONTAL POSITION** knob counter-clockwise to set the position readout on the top of the display to **M Pos: 20.00ms**.

This positions the waveform trigger point 20 milliseconds (ms) to the left of the center of the graticule.

- Turn the **SEC/DIV** knob clockwise to set the time base readout on the bottom of the display to **M 500 μ s**.

You will see the delayed trigger position for a waveform similar to that shown in Figure 4.3.

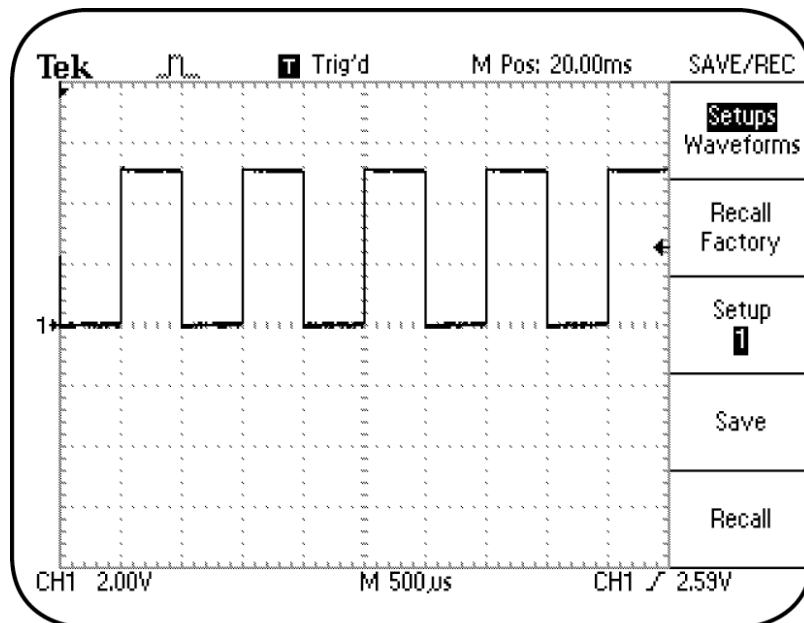

Figure 4.3: Delayed trigger position for a waveform

4

Using HORIZONTAL Controls

In this procedure, you used the **SEC/DIV** knob to modify the time base setting of a waveform. You also used the **HORIZONTAL POSITION** knob to change the position of the trigger point from the center of the graticule. The actions performed using the two knobs resulted in an expanded view of the waveform, centered around a delay of 20 milliseconds from the trigger point.

HORIZONTAL Control MENU Buttons

In this section, you will learn to use both the knobs and the menu options for HORIZONTAL controls to modify a displayed waveform.

Expanding the Waveform Display

In the previous procedure, you expanded the scale of the horizontal time of a displayed waveform at a delay time on the waveform. You can also delay and expand a waveform by using the **Window** menu option of the **HORIZONTAL** menu.

The following procedure enables you to use the **Window** and **Window Zone** menu options of the **HORIZONTAL** menu to view the horizontal component of a delayed waveform in the expanded form.

***Note:** This procedure assumes that the oscilloscope retains the settings from the previous procedure.*

To expand the waveform display, follow these steps:

1. In the HORIZONTAL section, push the **HORIZONTAL MENU** button.
2. Push the appropriate side-screen menu button to select **Window Zone**.

4

Using HORIZONTAL Controls

3. Turn the **HORIZONTAL POSITION** knob clockwise to move the vertical dotted line cursors to center around the last positive edge of the displayed waveform.
4. Turn the **SEC/DIV** knob clockwise to set the displayed window setting at the bottom of the display to **W 10.0us**.

You will see a waveform in the **Window Zone** display with the position delayed, similar to that shown in Figure 4.4.

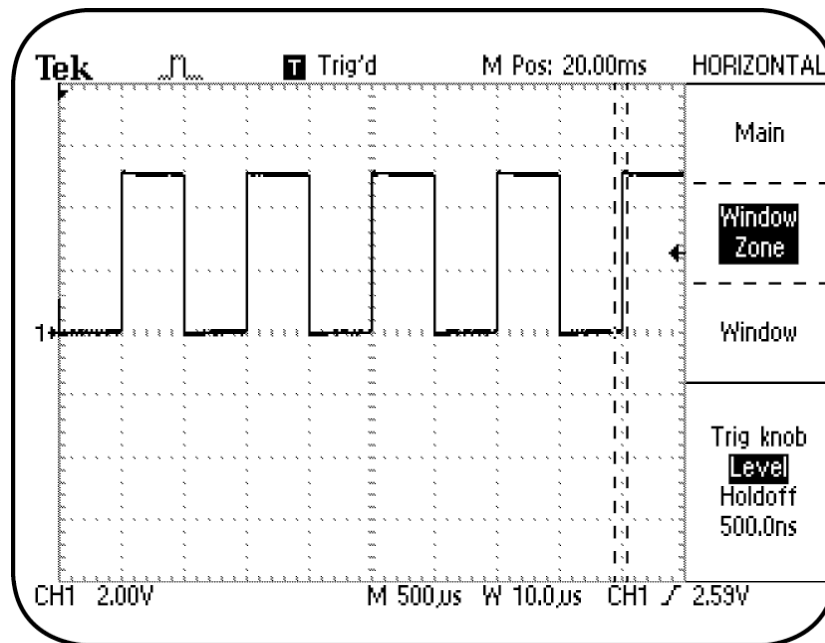

Figure 4.4: Position delayed and Window Zone display

5. Push the appropriate side-screen menu button to select **Window**.
6. In the **HORIZONTAL** section, turn the **POSITION** knob to position the rising edge of the displayed waveform at the center of the graticule.
7. Turn the **SEC/DIV** knob clockwise to set the time base setting at the bottom of the display to **W 500ns**.

You will see a waveform expanded by using the Window function similar to that shown in Figure 4.5.

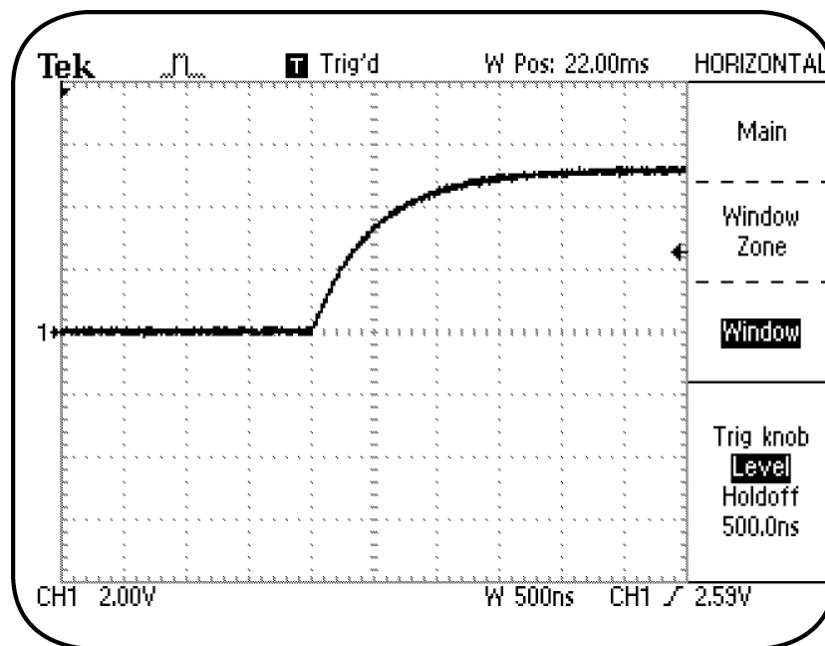

Figure 4.5: Expanded waveform using the Window function

4

Using HORIZONTAL Controls

Summary

In this module, you learned to perform the following tasks:

- Use the **SEC/DIV** knob of a to modify the horizontal scale of a displayed waveform.
- Use the HORIZONTAL **POSITION** knob to change the horizontal position of a displayed waveform.
- Expand the displayed waveform by setting a delay time for a displayed waveform.
- Use the **Window** and **Window Zone** menu options of the **HORIZONTAL** menu to expand a displayed waveform.

5

Using TRIGGER Controls

This module focuses on the TRIGGER controls on the front panel. The module provides procedures that you can use to modify a displayed waveform by using TRIGGER controls.

This module includes the following sections:

- TRIGGER Holdoff Control
- TRIGGER Control MENU Buttons

5

Using TRIGGER Controls

Trigger Holdoff Controls

Triggering a signal at the correct point is essential to ensure the proper display of a waveform. You can use the TRIGGER controls on the front panel to stabilize repeating signals, as well as to capture single-shot waveforms.

Figure 5.1 shows the TRIGGER control sections on the front panel.

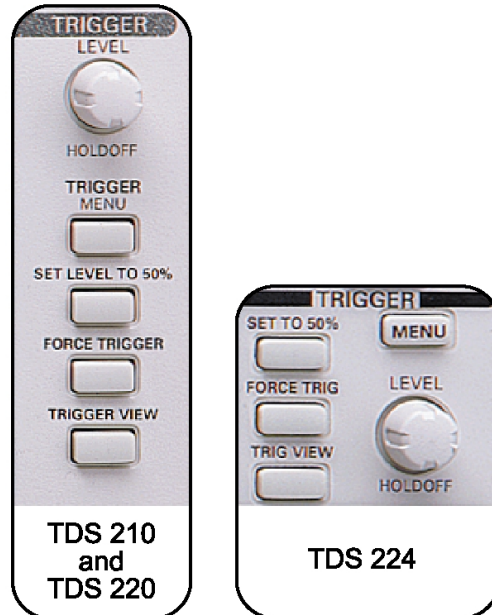

Figure 5.1: TRIGGER control sections

Setting Up TRIGGER Controls

Before you use the TRIGGER controls for operation exercises, you must ensure that the oscilloscope is set to its default setting.

This procedure enables you to set the default settings required for procedures with TRIGGER controls.

To set up a TDS200 oscilloscope for TRIGGER controls follow these steps:

1. Connect the CH1 probe tip to the **PSEUDO RANDOM** signal on pin 5 and the CH1 ground lead to **GND** on pin 7 of the Training 1 signal board.
2. On the Training 1 signal board, push the **POWER** button until the **Digital PWR** light is on.
3. On the top of the front panel, push the **SAVE/RECALL** menu button.
4. Push the appropriate side-screen menu button to select **Setups**.
5. Push the appropriate side-screen menu button to select **Recall Factory**.
6. On the top of the front panel, push the **AUTOSET** button.

5

Using TRIGGER Controls

You will see a waveform similar to that shown in Figure 5.2.

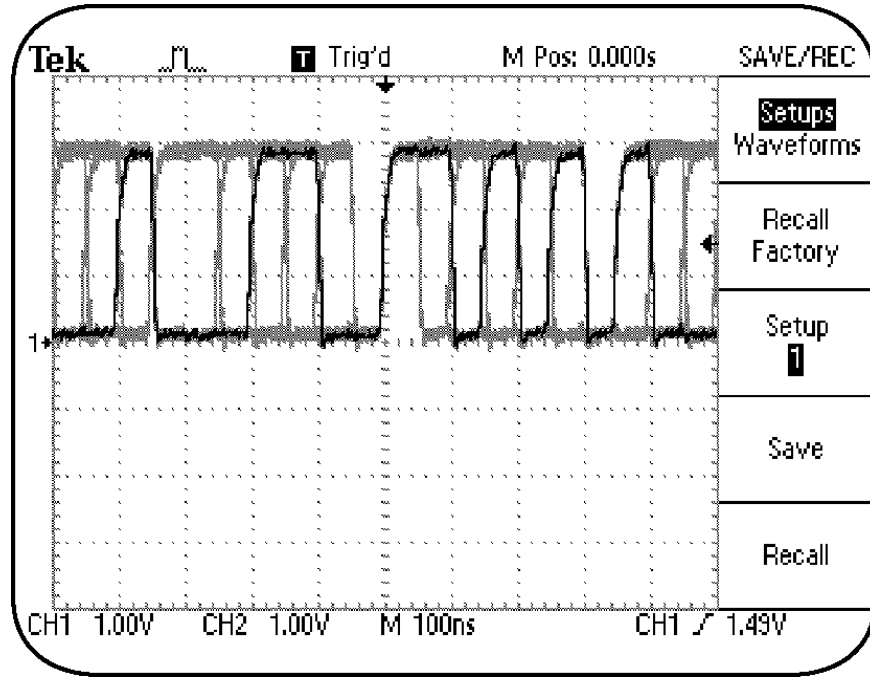

Figure 5.2: Pseudo random communications signal without holdoff

Figure 5.2 shows the varying details of a pseudo random communications signal. However, observe that the displayed signal updates itself continuously in such a way that you cannot see a stable waveform display. You can use various signal sources to trigger on the signal being measured, or trigger on a separate signal.

These can be an input signal from another channel, the oscilloscope power source, or an external input signal to the oscilloscope.

You can also use trigger holdoff to stabilize a complex repeating waveform. Trigger holdoff is an adjustable period after a trigger, within which an oscilloscope cannot trigger again. Trigger holdoff ensures that the oscilloscope displays a predictable trigger reference on a complex repeating waveform. Figure 5.3 explains the concept of trigger holdoff.

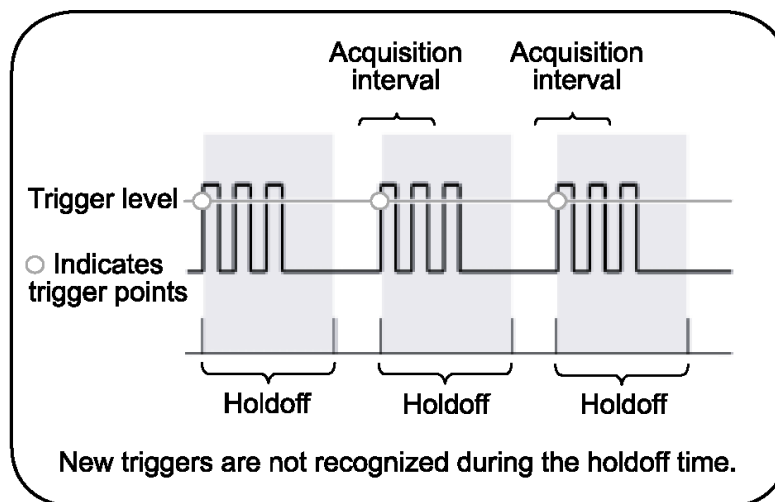

Figure 5.3: Trigger holdoff

5

Using TRIGGER Controls

Assigning Trigger Holdoff

The following procedure enables you to assign a holdoff time for the trigger generated by the **PSEUDO RANDOM** signal from pin 5 of the Training 1 signal board. This enables you to see a stable waveform display.

***Note:** This procedure assumes that the oscilloscope retains the settings from the previous procedure.*

To assign a trigger holdoff, follow these steps:

1. In the **HORIZONTAL** section, push the **HORIZONTAL MENU** button.
2. Push the appropriate side-screen menu button to select **Trig knob Holdoff**.
3. In the TRIGGER section, turn the **LEVEL/HOLDOFF** knob to set the displayed holdoff time to **5.950us**.

You will see a waveform similar to that shown in Figure 5.4.

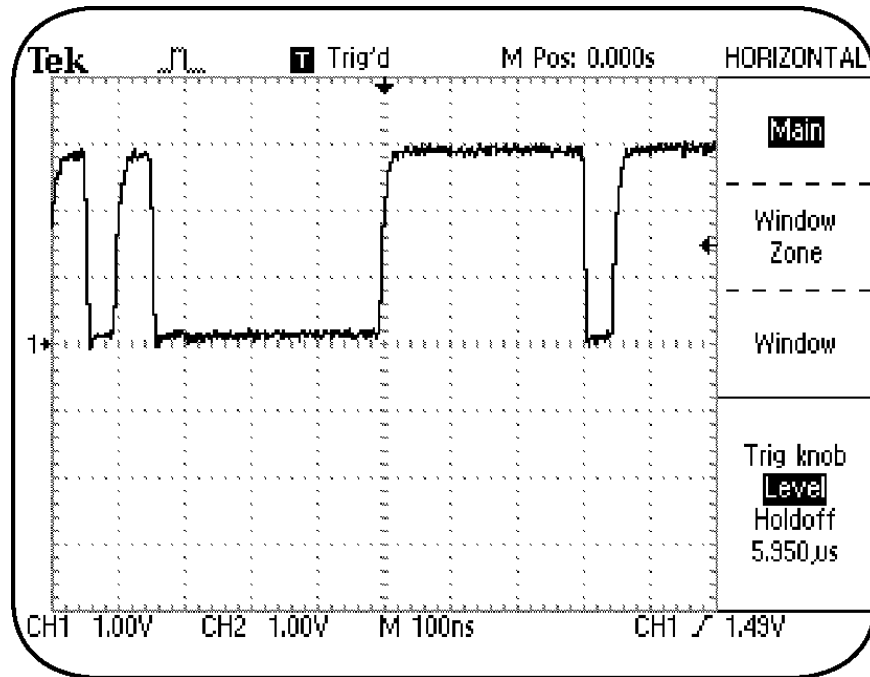

Figure 5.4: Stable display of pseudo random communications signal by using trigger holdoff

Observe that assigning a trigger holdoff time stabilizes the display of a repeating signal. You can also modify the horizontal scale of a displayed waveform by adjusting the sec/div setting. However, you cannot do this with an analog oscilloscope because the holdoff circuit includes the time base sweep time.

5

Using TRIGGER Controls

You can use the TRIGGER menu to assign a trigger holdoff for either edge or video triggering. In addition, you can assign a trigger holdoff when the oscilloscope is in the **Normal** or **Auto** trigger mode.

It may be difficult to see a stable display for a repeating digital signal, such as a pseudo random signal, on an oscilloscope because edge transitions occur at many places within the waveform.

You can view a stable waveform display of a complex repeating signal by assigning a trigger holdoff. This makes the oscilloscope trigger the signal within the interval of the signal's repeat time.

Assigning Trigger Holdoff With an AM Signal

In the previous procedure, you observed that triggering a complex repeating signal at the interval of the signal's repeat time displays a stable waveform. However, you may also need to analyze the waveform display of the amplitude modulation (AM) of a complex repeating signal. For example, you might want to analyze the modulation index of a radio frequency transmitter.

Figure 5.5 shows the updating overlay of the amplitude modulation region of an amplitude modulated (AM) signal.

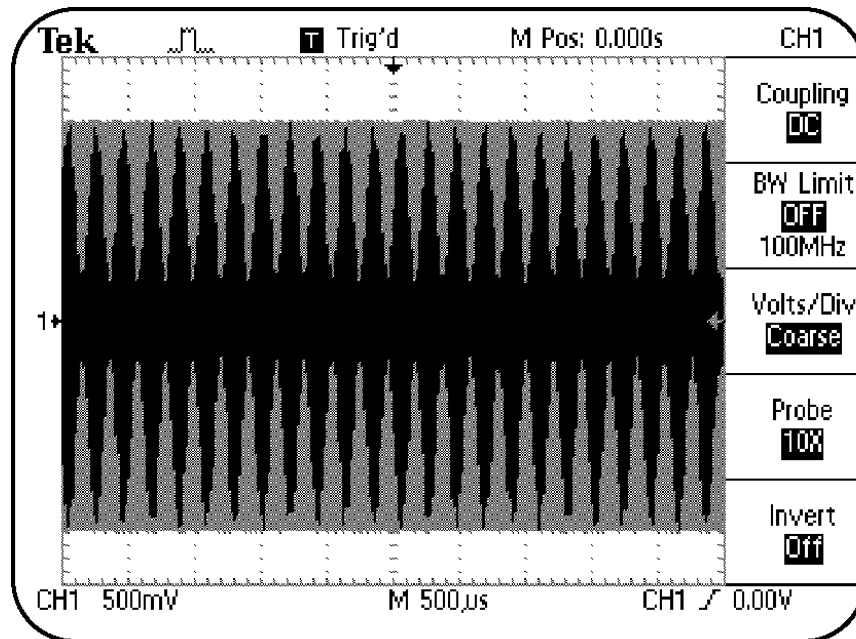

Figure 5.5: Complex AM signal without holdoff

To observe a stable display of the amplitude modulation of a complex repeating signal, you must adjust the trigger level within the amplitude modulation region of the displayed waveform.

5

Using TRIGGER Controls

The next procedure enables you to analyze the amplitude modulation region of a complex repeating signal by assigning a trigger holdoff in the amplitude modulation region of the signal.

To assign a trigger holdoff for an AM signal, follow these steps:

1. Connect the CH1 probe tip to **AM SIGNAL** on pin 9 and the CH1 probe ground lead to **GND** on pin 8 of the Training 1 signal board.
2. On the Training 1 signal board, push the **POWER** button until only the **Analog PWR** light is on.
3. On the top of the front panel, push **SAVE/RECALL**.
4. Push the appropriate side-screen menu button to select **Setups**.

5

Using TRIGGER Controls

5. Push the appropriate side-screen menu button to select **Recall Factory**.
6. In the **VERTICAL** section, turn the **Channel 1 VOLTS/DIV** knob to set CH1 for **500mV**.
7. In the **HORIZONTAL** section, turn the **SEC/DIV** knob to set the displayed time base for **M 50.0us**.
8. Push the **HORIZONTAL MENU** button.
9. In the **TRIGGER** section, turn the **LEVEL/HOLDOFF** knob to set the displayed trigger level to **1.00V**.
10. Push the appropriate side-screen menu button to select **Trig knob Holdoff**.
11. In the **TRIGGER** section, turn the **LEVEL/HOLDOFF** knob to set the displayed holdoff time to **100.0us**.

5

Using TRIGGER Controls

You will see a waveform similar to that shown in Figure 5.6.

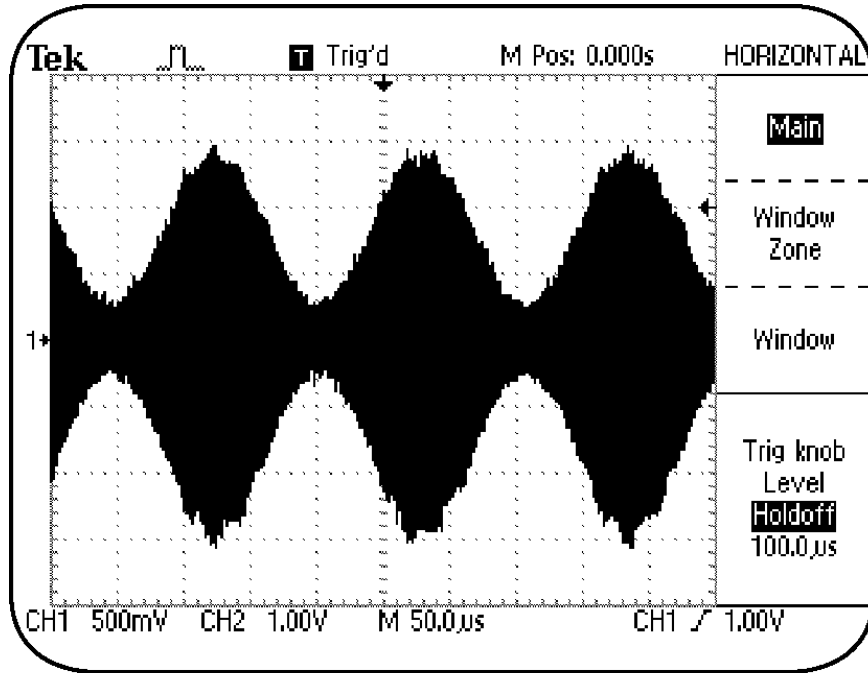

Figure 5.6: Stable AM signal using trigger holdoff

You can view the stable waveform display of the amplitude modulation region of an AM signal by assigning a trigger holdoff time to be within the amplitude-modulated region of the signal.

TRIGGER Control MENU Buttons

In this section, you will learn how to stabilize a displayed waveform by using the **TRIGGER MENU** controls.

Using an External Trigger

You can select various sources, such as an input channel or the power source of the oscilloscope to trigger a displayed signal. On the TDS210 and TDS220 oscilloscopes, you can also select an external signal source as the trigger signal.

Note: *The TDS224 oscilloscope does not support an external trigger input. You must use one of the four input channels as the trigger input signal.*

Consider an example where you have a circuit that uses a clock signal as a reference. You can use this clock signal as the external trigger input source and use a probe from an oscilloscope channel to check the referenced signal at various points in the circuit. You can then view the behavior of the circuit relative to the trigger reference of the clock signal.

5

Using TRIGGER Controls

The following procedure enables you to use an external trigger source or unused channel, other than the displayed acquisition input channels, to trigger a displayed signal. You can use the external trigger input (or an unused channel) to trigger on certain unique aspects of this trigger signal.

To use an external (or an unused channel) input as a trigger, follow these steps:

1. Connect the CH1 probe tip to the **PSEUDO RANDOM** signal on pin 5 and the CH1 ground lead to **GND** on pin 7 of the Training 1 signal board.
2. On the top of the front panel, push the **SAVE/RECALL** menu button.
3. Push the appropriate side-screen menu button to select **Setups** and then select **Recall Factory**.
4. On the Training 1 signal board, push the **POWER** button until the **Digital PWR** light is on.

5. On the top of the front panel, push the **AUTOSET** button.
6. Connect a (10x passive) probe to the **EXT TRIG** input connector (or to the **CH3** input connector on a TDS224 oscilloscope).
7. Connect the external (or CH3) trigger probe tip to the **CLK 20MHz** signal on pin 2 and the external (or CH3) trigger probe ground lead to **GND** on pin 1 of the Training 1 signal board.
8. In the TRIGGER section, push the **TRIGGER MENU** button.
9. Push the appropriate side-screen menu buttons to select **Slope Falling** and **Source Ext** (or **CH3** for a TDS224 oscilloscope).
10. In the TRIGGER section, turn the **LEVEL/HOLDOFF** knob to set the trigger level to **256mV** (or to **2.56V** on a TDS224 oscilloscope).
11. In the **VERTICAL** section, turn the **Channel 1 VOLTS/DIV** knob to set **CH1 500mV** on the display.
12. Turn the **Channel 1 POSITION** knob to position the waveform at the center of the display.

5

Using TRIGGER Controls

13. In the HORIZONTAL section, turn the **SEC/DIV** knob to set the time base as **M 10.0ns** on the display.

You observe that the pseudo random signal on pin 5 is triggered by the **CLK 20MHz** signal from pin 2. You will see an Eye Diagram display similar to that shown in Figure 5.7.

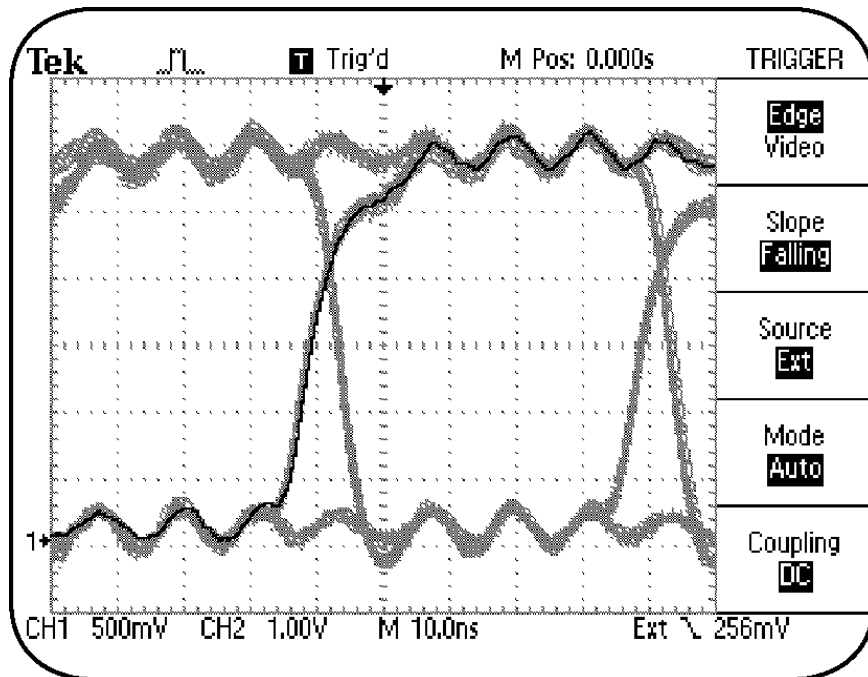

Figure 5.7: Eye Diagram display of pseudo random signal triggered by external clock signal

As the **EXT TRIG** input on the TDS210 or TDS220 oscilloscope has a 10X probe connected to it, the trigger level is actually 10 times more than as shown on the display. You can further extend the external trigger level range of the TDS210 and TDS220 oscilloscopes. You do this by selecting the **EXT/5** trigger source. The **EXT/5** option divides the signal from the external source by five to increase the trigger level range.

Selecting a Trigger Type

You can select edge triggering or video triggering for a signal by using the menu buttons for TRIGGER controls on the front panel.

You use edge triggering to trigger on the edge of a signal at the trigger threshold. In other words, the rising or falling edge of the input signal is used for the trigger.

You use video triggering to trigger on the fields or lines of an NTSC, PAL, or SECAM standard video signal. When you choose video triggering on a TDS200 oscilloscope, the trigger is automatically referenced to the negative part of the video signal. This ensures proper line and field triggering over a wide range of vertical amplitude and offset.

5

Using TRIGGER Controls

The following procedure enables you to choose the Edge trigger selections to trigger the input signal according to your requirements.

To trigger on the edge of the input signal, follow these steps:

1. Connect the CH1 probe tip to the **PROBE COMP** signal and the CH1 ground lead to **GND** on the front panel.
2. On the top of the front panel, push the **SAVE/RECALL** menu button.
3. Push the appropriate side-screen menu button to select **Setups** and then select **Recall Factory**.
4. On the top of the front panel, push the **AUTOSET** button.
5. In the HORIZONTAL section, turn the **SEC/DIV** knob to set the time base setting on the display for **M 2.50us**.
6. In the TRIGGER section, push the **TRIGGER MENU** button.

7. Push the appropriate side-screen menu button to select **Edge**.
8. In the TRIGGER section, turn the **LEVEL/HOLDOFF** knob to set the trigger level to **1.52V**.

You will see a display showing Edge triggering setup, similar to that in Figure 5.8.

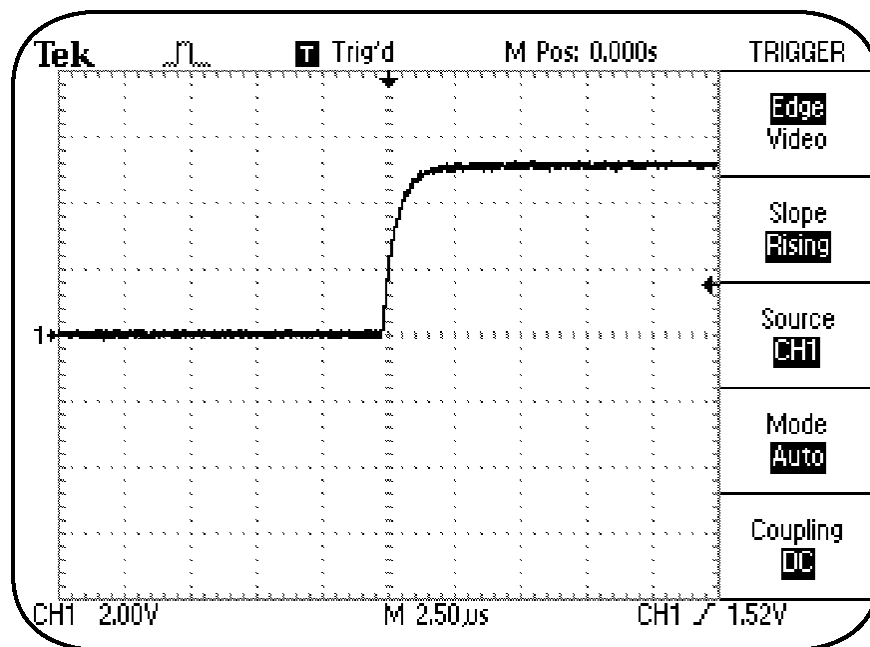

Figure 5.8: Edge triggering

5

Using TRIGGER Controls

Selecting the Signal Coupling for a Trigger

You can select the coupling type for a trigger when you choose edge triggering. You can choose to select **AC**, **DC**, **Noise Reject**, **HF Reject**, or **LF Reject** coupling for a trigger.

The following procedure enables you to condition the trigger signal used to trigger an acquisition by setting a coupling type for the trigger.

***Note:** This procedure assumes that the oscilloscope retains the settings from the previous procedure.*

To select a coupling type for a trigger, follow these steps:

1. Push the appropriate side-screen menu button to select **Coupling HF Reject**.

The displayed waveform has shifted to the left.

2. In the TRIGGER section, push and hold the **TRIGGER VIEW** button.

You will see a waveform similar to that shown in Figure 5.9. This trigger signal has a slower rise time and is the result of the low pass HF reject filter. This trigger selection rejects the high-speed components in the triggering signal.

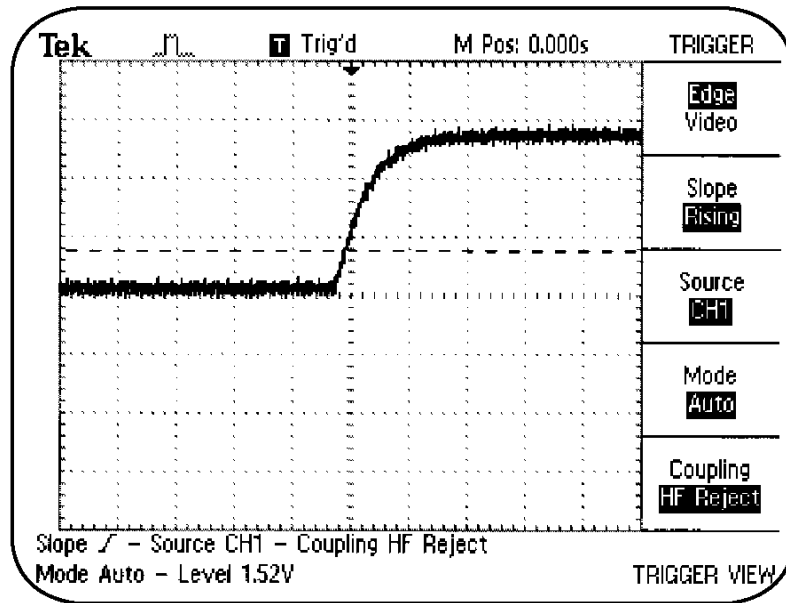

Figure 5.9: Triggering waveform with HF Reject coupling

You select **HF Reject** coupling to trigger a signal when you need to pass only the slower speed components of a signal below 50 kHz sine wave bandwidth equivalent.

5

Using TRIGGER Controls

On the other hand, **Noise Reject** coupling allows all components of a signal to pass to the trigger circuit, but increases the peak-to-peak signal required to trigger the signal. **LF Reject** is an AC coupled triggering mode that passes only the higher speed signal details above 50kHz sine wave bandwidth equivalent. AC trigger coupling passes signals above 10Hz sine wave bandwidth equivalent.

You can now try the other coupling selections of the oscilloscope, and use the **TRIGGER VIEW** button to see the effects of trigger coupling on the triggering signal.

Summary

In this module, you learned to perform the following tasks:

- Assign a trigger holdoff for a repeating signal.
- Assign a trigger holdoff for a complex repeating signal such as a pseudo random signal.
- Assign a trigger holdoff for an AM signal.
- Use an external signal to trigger a waveform.
- Use edge and video triggering.
- Select the coupling type for a trigger.

5

Using TRIGGER Controls

6

Using Menu Function Controls

This module provides information about the menu function controls on the front panel in combination with the various primary control sections.

This module includes the following sections:

- **ACQUIRE** Menu Function Controls
- **DISPLAY** Menu Function Controls
- **CURSOR** Menu Function Controls
- **MEASURE** Menu Function Controls
- **SAVE/RECALL** Menu Function Controls
- **UTILITY** Menu Function Controls

6

Using Menu Function Controls

ACQUIRE Menu Function Controls

You use the acquisition modes of a TDS200 oscilloscope to control how waveforms are acquired and displayed from the sample points taken on a signal.

A TDS200 oscilloscope acquires 2500 sample points for each active channel during every acquisition of the respective signals. Sample points are derived directly from the Analog to Digital Converter for each channel the oscilloscope. The time value difference between two sample points is called the sample interval.

The **Sample** mode is the default acquisition mode. In the sample mode, the oscilloscope creates one waveform point during the sample interval of each waveform.

It is possible to miss fast glitches when the time between displayed samples is very long. You use the **Peak Detect** acquisition mode to detect glitches in fast moving signals at slow time base settings.

You use the **Average** acquisition mode to reduce random noise in a displayed signal. You can select the number of waveforms to be averaged.

Using the Average Acquisition Mode

You use the **Average** acquisition mode to reduce the random noise in a displayed signal by taking an average of multiple waveforms. The **Average** acquisition mode uses the **Sample** acquisition mode to acquire data and then takes an average of multiple waveforms to display a final waveform. You can take an average of 4, 16, 64, or 128 waveforms to display each waveform.

In the following procedure, you will limit the random noise in a signal. You will first acquire a waveform by using the **Sample** acquisition mode and then average it by the **Average** acquisition mode.

To use the average acquisition mode to acquire a waveform, follow these steps:

1. Connect the CH1 probe to the **VARIABLE AMPL WITH GLITCH** signal on pin 15 and the CH1 probe ground lead to **GND** on pin 14 of the Training 1 signal board.

6

Using Menu Function Controls

2. On the Training 1 signal board, push the **POWER** button until only the **Analog PWR** light is on.
3. On the top of the front panel, push **SAVE/RECALL**.
4. Push the appropriate side-screen menu buttons to select **Setups** and then select **Recall Factory**.
5. In the TRIGGER section, turn the **LEVEL/HOLDOFF** knob to set the trigger level to **400mV** on the display.
6. Push the **TRIGGER MENU** button.
7. Push the appropriate side-screen menu button to select **COUPLING HF Reject**.

You will see a waveform similar to that shown in Figure 6.1.

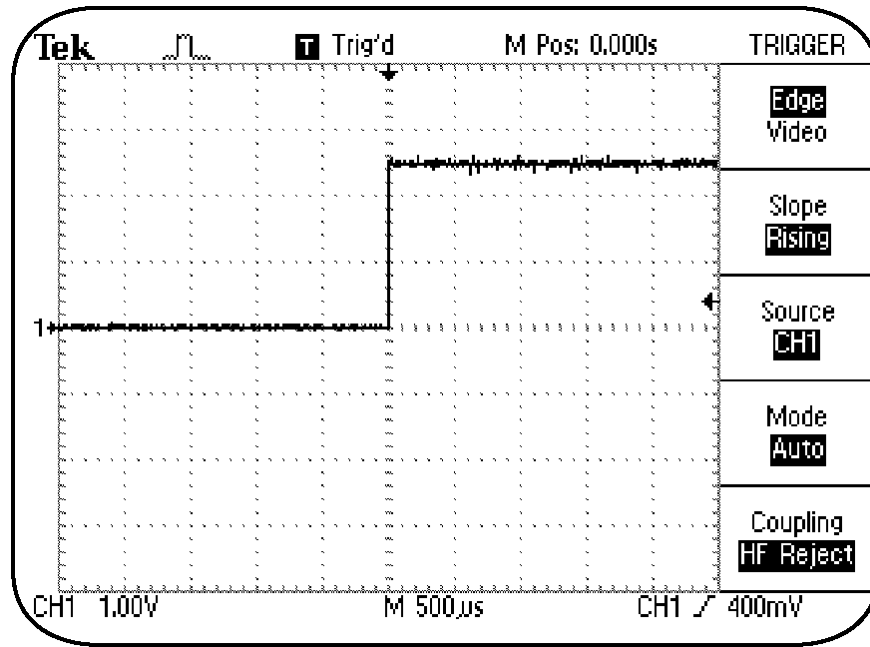

Figure 6.1 Noisy variable amplitude signal, acquired with Sample acquisition mode

The waveform is acquired by the default **Sample** acquisition mode. You will now use the **Average** acquisition mode to reduce the displayed noise in the repeating signal

8. On the top of the front panel, push the **ACQUIRE** menu button.

6

Using Menu Function Controls

9. Push the appropriate side-screen menu button to select **Average**.

You will see a waveform similar to that shown in Figure 6.2.

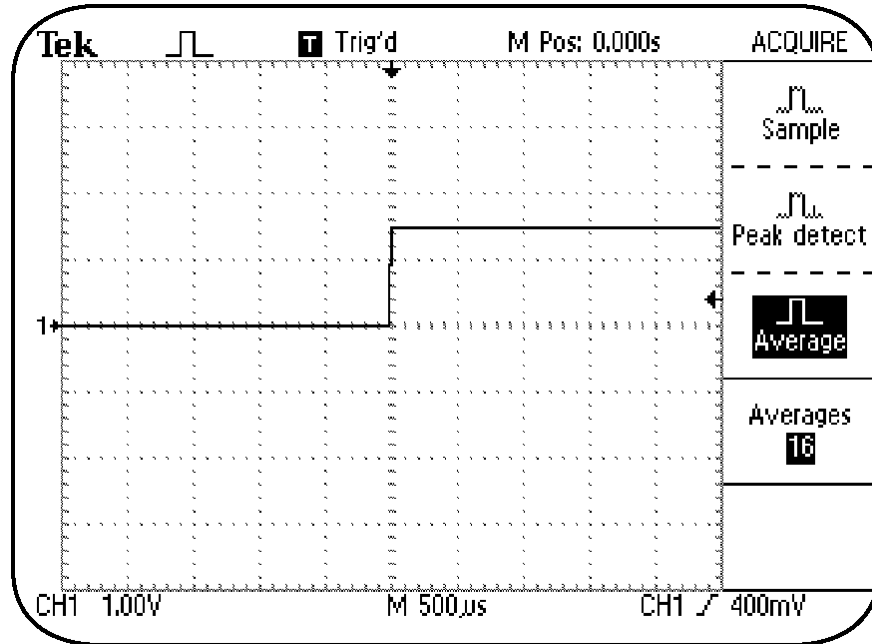

Figure 6.2: Noisy variable amplitude signal, acquired with Average acquisition mode

You will observe that the signal noise is reduced when you shift from the **Sample** to the **Average** acquisition mode.

Using the Peak Detect Acquisition Mode

You use the **Peak Detect** acquisition mode to capture fast signal glitches that fall between acquisition samples at slower time base settings. You need to use **Peak Detect** acquisition when high-speed interference couples with electronic signals. For example, consider a situation where you need to test a complex signal that controls a mechanical robot. You can use the **Peak Detect** mode to check the signal for glitches caused by various sources, such as light dimmers, motor controls, and design flaws.

You use the scan mode to display signal updates from left to right on the oscilloscope. The scan mode simulates the display of an analog oscilloscope and allows you to see new waveform information as it is acquired on the oscilloscope. A TDS200 oscilloscope enters the scan mode when the **SEC/DIV** knob is set to 100 ms and the trigger mode is set to **Auto**.

6

Using Menu Function Controls

The following procedure enables you to detect glitches in the signal at slow time base settings by selecting the **Peak Detect** acquisition mode and the scan display mode.

***Note:** This procedure assumes that the oscilloscope retains the settings from the previous procedure.*

To select the **Peak Detect** acquisition mode and the scan display mode, follow these steps:

1. In the HORIZONTAL section, turn the **SEC/DIV** knob counterclockwise to set the displayed time base setting to **M 100ms**.
2. Push the appropriate side-screen menu button to select **Peak detect**.

You will see a waveform similar to that shown in Figure 6.3.

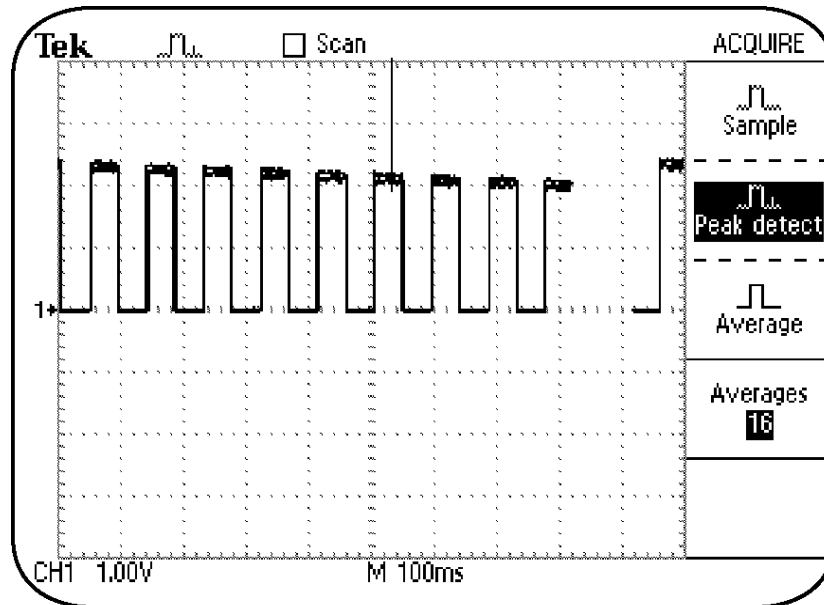

Figure 6.3: Noisy variable amplitude signal with glitches, acquired with Peak detect mode and scan display mode

Note that random glitches appear on the waveform. These glitches are not visible in **Sample** acquisition mode. Try selecting **Sample** mode, and then **Peak detect** mode to view the difference.

6

Using Menu Function Controls

Step Response

In addition to the noise generated from the signal, probes and ground leads also cause signal distortions.

For example, probe tip and ground leads have an amount of additional inductance. This inductance interacts with the probe and circuit capacitance to cause a damped sinusoidal variation on pulses with fast edge transitions. This effect of probe tip and ground leads on pulse waveforms is called ringing.

Probe loading caused by probe tip leads and ground leads can cause incorrect measurements and/or circuits to fail.

In the following step response procedure, you use the single shot **FAST RISE TIME** signal on pin 16 of the Training 1 signal board to check the amount of signal distortion caused by the probe tip and ground lead.

To perform the step response demonstration, follow these steps:

1. Connect the CH1 probe tip to the **FAST RISE TIME** signal on pin 16 and the CH1 ground lead to **GND** on pin 1 of the Training 1 signal board.
2. On the top of the front panel, push the **SAVE/RECALL** menu button.
3. Push the appropriate side-screen menu button to select **Setups** and then select **Recall Factory**.
4. In the **VERTICAL** section, turn the **Channel 1 VOLTS/DIV** knob for a readout of **200mV**.
5. In the **VERTICAL** section, turn the **Channel 1 POSITION** knob to position the trace two divisions above the bottom of the display.
6. In the **HORIZONTAL** section, turn the **SEC/DIV** knob clockwise for a time base readout of **M 5.00ns**.
7. In the **TRIGGER** section, push the **TRIGGER MENU** button.
8. Push the appropriate side-screen menu button to select **Mode Normal**.

6

Using Menu Function Controls

9. In the TRIGGER section, turn the **LEVEL/HOLDOFF** knob to set the trigger level to **200mV**.
10. On the Training 1 signal board, push the **PRESS FOR SINGLE SHOT** button to generate a high-speed single shot signal.

You will see a waveform similar to that shown in Figure 6.4.

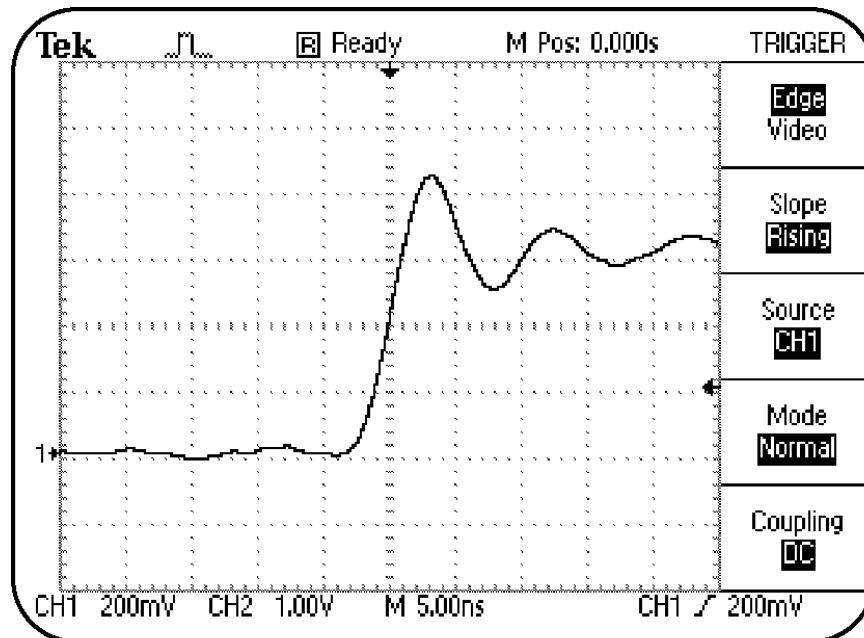

Figure 6.4: Step response waveform with ground lead

The overshoot and ringing is caused by the inductance of the probe ground and signal tip leads that interact with the probe and circuit capacitance.

To view the step response signal without overshoot and ringing, follow these steps:

1. Pull the probe tip out of the probe tip lead.
2. Insert exposed probe tip into the probe socket on the Training 1 signal board.
3. On the Training 1 signal board, push the **PRESS FOR SINGLE SHOT** button to generate a high-speed single shot signal.

6

Using Menu Function Controls

You will see a waveform similar to that shown in Figure 6.5.

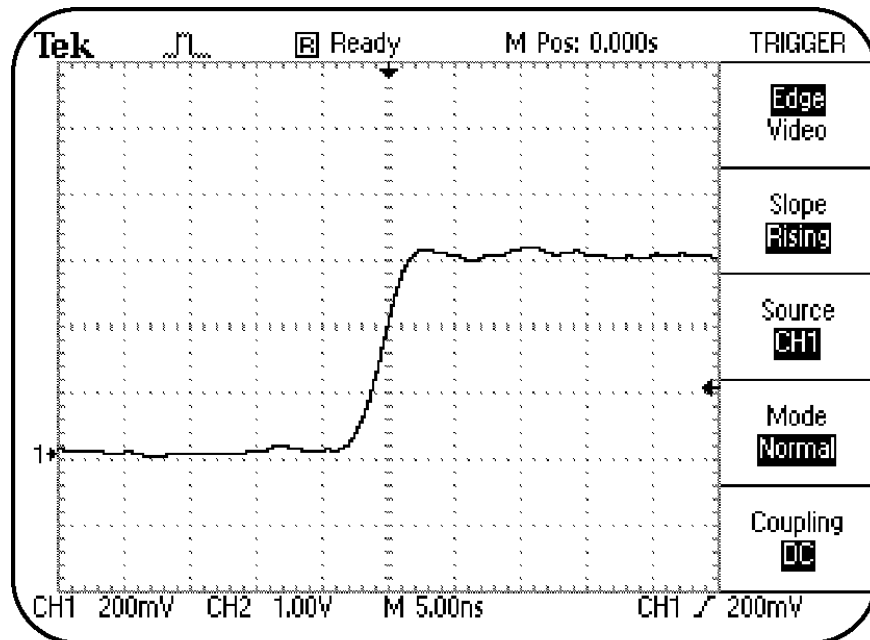

Figure 6.5: Step response waveform without ground lead

Note that the step response does not have ringing when the probe ground and signal tip leads are kept short.

DISPLAY Menu Function Controls

You use the **DISPLAY** menu function controls to control how waveforms are displayed. You can use various menu options, such as **Type**, **Persist**, and **Format** of the DISPLAY menu to change the appearance of the oscilloscope display.

Selecting the Display Type

You can select different display types for a waveform. You can choose either a vector or dot display type for a waveform by using the options of the DISPLAY menu. When you choose **Vectors**, straight lines connect the sample points on the display. When you choose **Dots**, only the sample points are displayed.

The following procedure enables you to change the appearance of a waveform by changing the display selections for a waveform.

6

Using Menu Function Controls

To change the display type of a waveform, follow these steps:

1. Connect the CH1 probe tip to the **D-10 MHz** signal on pin 3 of the Training 1 signal board.
2. Connect the CH1 probe ground lead to **GND** on pin 1 of the Training 1 signal board.
3. On the Training 1 signal board, push the **POWER** button until the **Digital PWR** light is on.
4. On the top of the front panel, push the **SAVE/RECALL** menu button.
5. Push the appropriate side-screen menu buttons to select **Setups** and then select **Recall Factory**.
6. On the top of the front panel, push the **AUTOSET** button.
7. In the HORIZONTAL section, turn the **SEC/DIV** knob to set the displayed time base to **500ns**.
8. On the top of the front panel, push the **RUN/STOP** button to stop signal acquisitions by the oscilloscope.

You will see the caption **Stop** displayed at the top of the oscilloscope display.

9. On the top of the front panel, push the **DISPLAY** menu button.
10. Push the appropriate side-screen menu button to toggle between **Type Dots** and **Type Vectors**.

For **Type Dots**, you will see a waveform similar to that shown in Figure 6.6. Note that this waveform is made up by dots and is very difficult to see.

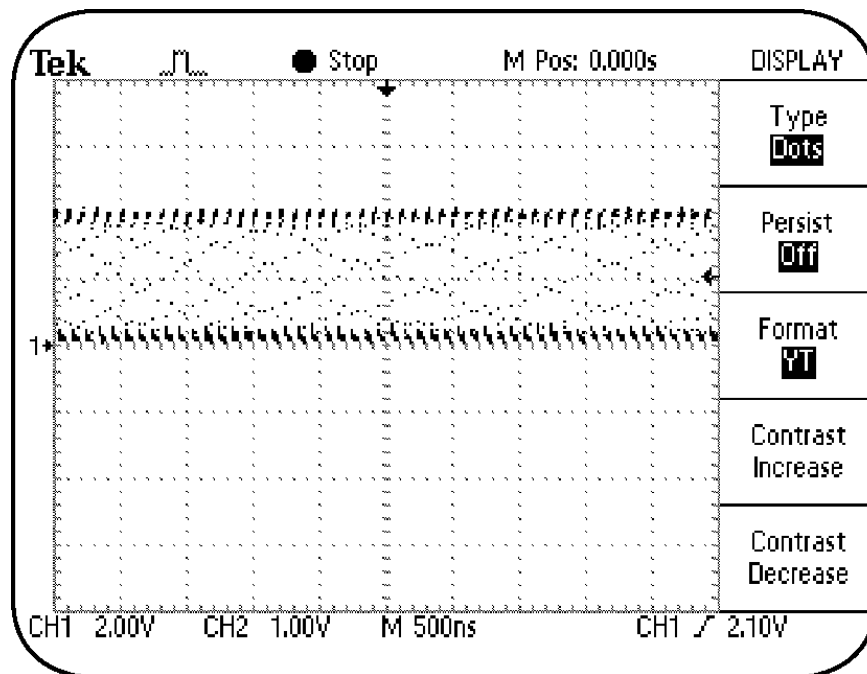

Figure 6.6: Waveform displayed in dots

6

Using Menu Function Controls

Using Persistence

You use the **Persist** mode to allow old waveform data to remain visible with the current waveform data on the oscilloscope display. When you use persistence, the old data is displayed in gray while the current data is displayed in black. You can use persistence to track infrequent signal anomalies that accumulate in the oscilloscope display.

You can set persistence for 1, 2, and 5 seconds, or for an infinite period.

The following procedure enables you to simultaneously view both old and new waveforms by using the **Persist Infinite** mode.

***Note:** This procedure assumes that the oscilloscope retains the settings from the previous procedure.*

To select a persistence period for a displayed waveform, follow these steps:

1. Push the appropriate side-screen menu button to select **Type Dots**.

2. Push the appropriate side-screen menu button until you select **Persist Infinite**.
3. On the top right of the front panel, push the **RUN/STOP** button twice.

This will start and then stop the accumulation of dots over many waveforms.

You will see a waveform similar to that shown in Figure 6.7.

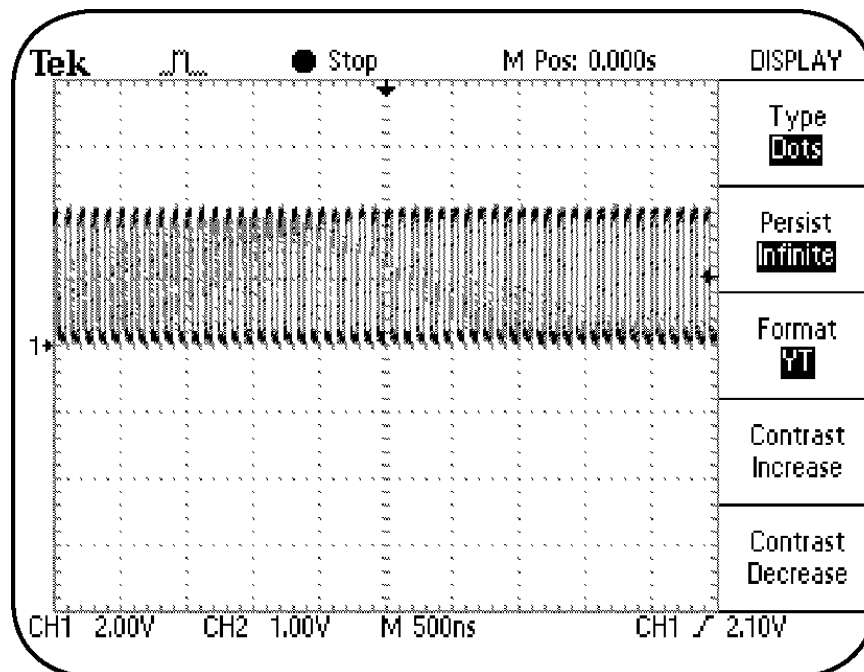

Figure 6.7: Noisy signal with infinite persistence

6

Using Menu Function Controls

4. In the **VERTICAL** section, turn the **Channel 1 POSITION** knob to move the waveform down.

Note that all but the last waveform acquisition dots disappear from the display.

You will see a waveform similar to that shown in Figure 6.8.

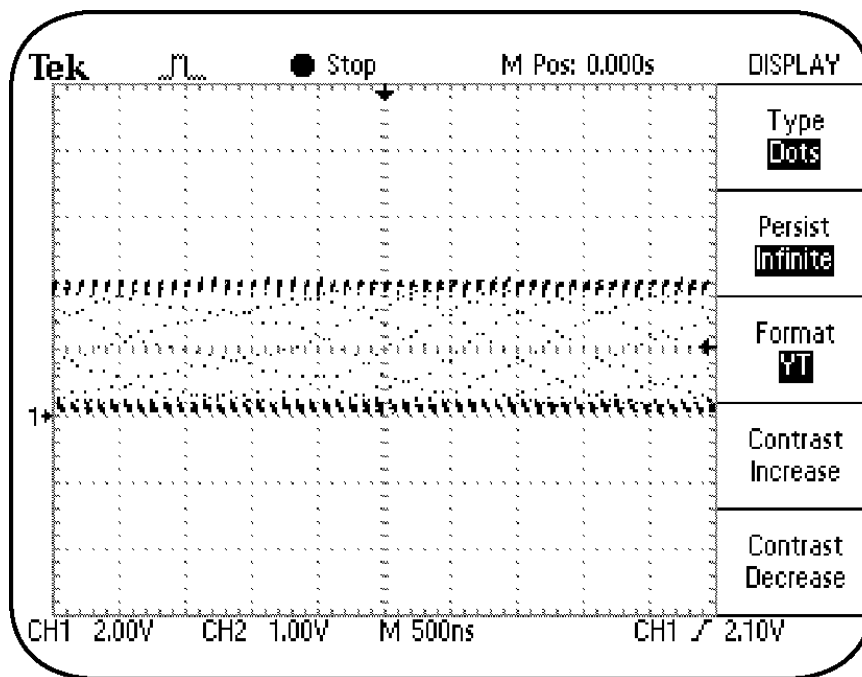

Figure 6.8: Noisy signal, final waveform acquisition dots displayed

Using the XY Display Mode

You can display waveforms in the XY or YT formats. When you choose the XY display format, Channel 1 is displayed on the horizontal axis and Channel 2 is displayed on the vertical axis. When you choose the YT format, the vertical voltage is displayed in relation to time.

You use the XY display format to measure the phase relationship between two or more synchronous signals. For example, you can measure a Quadrature Amplitude Modulation (QAM) communication signal with an XY constellation diagram.

The following procedure enables you to see the phase shift between two synchronous signals by displaying the two signals in the XY format.

To use the XY format to display a waveform, follow these steps:

1. Connect the CH1 probe tip to the **5 kHz SINE** signal on pin 10 and the CH1 ground lead to **GND** on pin 8 of the Training 1 signal board.

6

Using Menu Function Controls

2. Re-connect a P2100 probe to the CH2 input. Connect the CH2 probe tip to the **PHASE SHIFTED SINE WAVE** signal on pin 11 and the CH2 ground lead to **GND** on pin 14 of the Training 1 signal board.
3. On the Training 1 signal board, push the **POWER** button until only the **Analog PWR** light is on.
4. On the top of the front panel, push the **SAVE/RECALL** menu button.
5. Push the appropriate side-screen menu buttons to select **Setups** and then **Recall Factory**.
6. On the top of the front panel, push the **AUTOSET** button.
7. On the top of the front panel, push the **DISPLAY** menu button.
8. Push the appropriate side-screen menu button to select **Format XY**.
9. Turn the **Channel 1 VOLTS/DIV** knob to set the Channel 1 volts/div setting to **200mV** and the **Channel 2 VOLTS/DIV** knob to set the Channel 2 volts/div setting to **200mV**.

10. On the Training 1 signal board, turn the **ADJ** knob to display the XY signal as a circle.

The circle means that both the signals are sine waves and are 90° out of phase with respect to each other.

You will see a waveform similar to that shown in Figure 6.9.

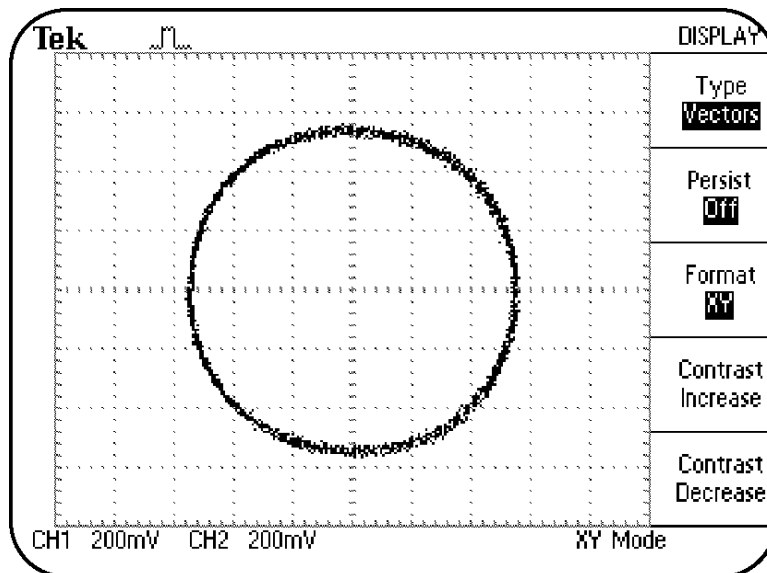

Figure 6.9: XY Display of two sine waves, with 90° of phase shift

You can use the XY display format to set or measure the phase shift between two synchronous signals with a phase difference.

6

Using Menu Function Controls

CURSOR Menu Function Controls

You can use the CURSOR menu function controls to measure the vertical or horizontal details of a waveform. You can manually select the horizontal (voltage) and vertical (time) cursors to view the values of the cursor positions.

The horizontal and vertical cursors are visible as dotted lines on the screen. You control the cursors with the CH1 and CH2 VERTICAL **POSITION** knobs when the CURSOR menu is selected.

Measuring the Vertical Scale

The following procedure enables you to manually measure the vertical scale of a waveform and calculate the volts/amplitude of the waveform.

Note: *This procedure assumes that the oscilloscope retains the settings from the previous procedure.*

To measure the vertical scale of a waveform, follow these steps:

1. On the top of the front panel, push the **SAVE/RECALL** menu button.
2. Push the appropriate side-screen menu buttons to select **Setups** and then **Recall Factory**.
3. On the top of the front panel, push the **AUTOSET** button.
4. On the top of the front panel, push the **CURSOR** menu button.
5. Push the appropriate side-screen menu button to select **Type Voltage**.

Ensure that **Source CH1** is selected.

6. In the **VERTICAL** section, turn the **Channel 1 POSITION** knob to position the associated cursor on the lowest point of the waveform.
7. Turn the **Channel 2 POSITION** knob to position the associated cursor on the highest peak of the waveform.

6

Using Menu Function Controls

8. Read the peak-to-peak volts/amplitude measurement for the waveform in the side-screen menu box **Delta**.

You will see a waveform similar to that shown in Figure 6.10. The measurement displayed in **Delta** is the peak-to-peak volts/amplitude measurement for the **5 kHz SINE** signal from pin 10 on the Training 1 signal board.

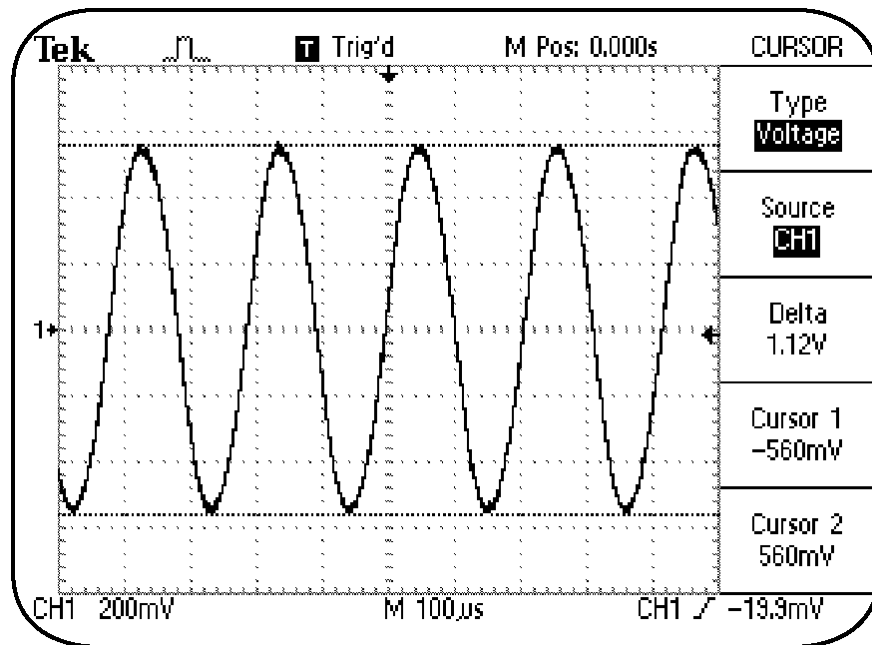

Figure 6.10: Volts/amplitude measurement for 5 kHz sine wave

Measuring the Horizontal Scale

The following procedure enables you to manually measure horizontal timing details on a waveform and display the period and frequency of the waveform.

Note: *This procedure assumes that the oscilloscope retains the settings from the previous procedure.*

To measure horizontal timing details on a waveform, follow these steps:

1. On the top of the front panel, push the **CURSOR** menu button.
2. Push the appropriate side-screen menu button to select **Type Time**.
3. In the **HORIZONTAL** section, turn the **SEC/DIV** knob to set the readout at the bottom of the screen to **M 25.0us**.
4. In the **VERTICAL** section, turn the **Channel 1 POSITION** knob to position the associated cursor on the left of the waveform cycle, where the sine wave crosses negatively through the center display graticule line.

6

Using Menu Function Controls

5. Turn the **Channel 2 POSITION** knob to position the associated cursor on the right of the waveform cycle, where the sine wave crosses negatively through the center display graticule line.
6. Read the period and frequency measurements for the waveform in the side-screen menu box **Delta**.

You will see a waveform similar to that shown in Figure 6.11. The measurements displayed in **Delta** are the period and frequency measurements for the **5 kHz SINE** signal from pin 10 on the Training 1 signal board.

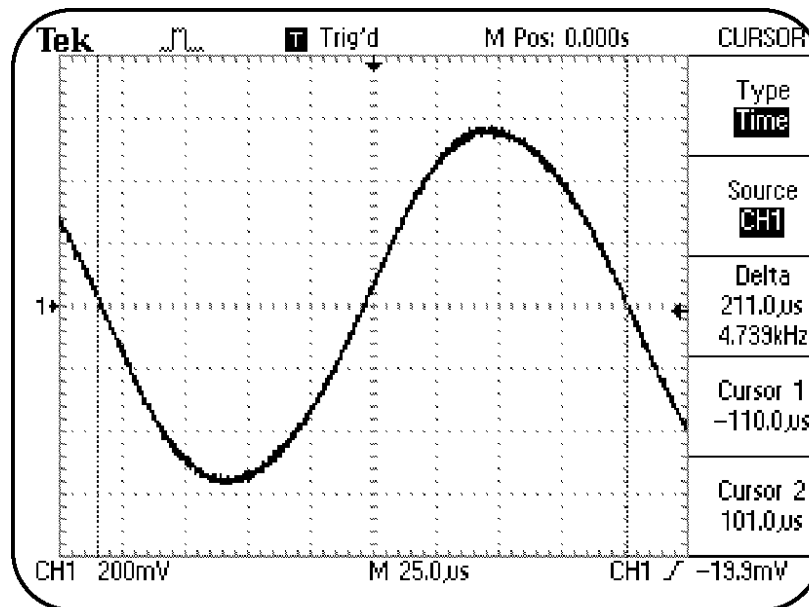

Figure 6.11: Period and frequency measurements for 5 kHz sine wave

Measuring Pulse Width

Pulse width is the time period during which a pulse moves from low to high and then back to low again. Pulse width is measured at 50 % of the full peak-to-peak voltage.

You can measure the width of a pulse by using the CURSOR menu. You may need to measure pulse width to ensure that variations in pulses do not cause malfunctioning in a digital circuit.

The following procedure will enable you to measure the width of a pulse by using time cursors.

To measure the width of a pulse, follow these steps:

1. Connect the CH1 probe tip to the **D-10 MHz** signal from pin 3 and the CH1 ground lead to **GND** on pin 1 of the Training 1 signal board.
2. On the Training 1 signal board, push the **POWER** button until the **Digital PWR** light is on.
3. On the top of the front panel, push the **SAVE/RECALL** menu button.
4. Push the appropriate side-screen menu buttons to select **Setups** and then select **Recall Factory**.

6

Using Menu Function Controls

5. On the top of the front panel, push the **AUTOSET** button.
6. In the HORIZONTAL section, turn the **SEC/DIV** knob to set the time base for **M 25.0ns** on the display.
7. On the top of the front panel, push the **CURSOR** menu button.
8. Push the appropriate side-screen menu button to select **Type Time**.
9. In the **VERTICAL** section, turn the **Channel 1 POSITION** knob to position the associated cursor at the 50% point on the rising edge of the pulse at the center of the display.
10. Turn the **Channel 2 POSITION** knob to position the associated cursor at the 50% point on the falling edge of the pulse after the center of the display.
11. Read the pulse width measurement for the pulse in the side-screen menu box **Delta**.

You will see a waveform similar to that shown in Figure 6.12. The measurement displayed in **Delta** is the pulse width for the **D-10 MHz** signal from pin 3.

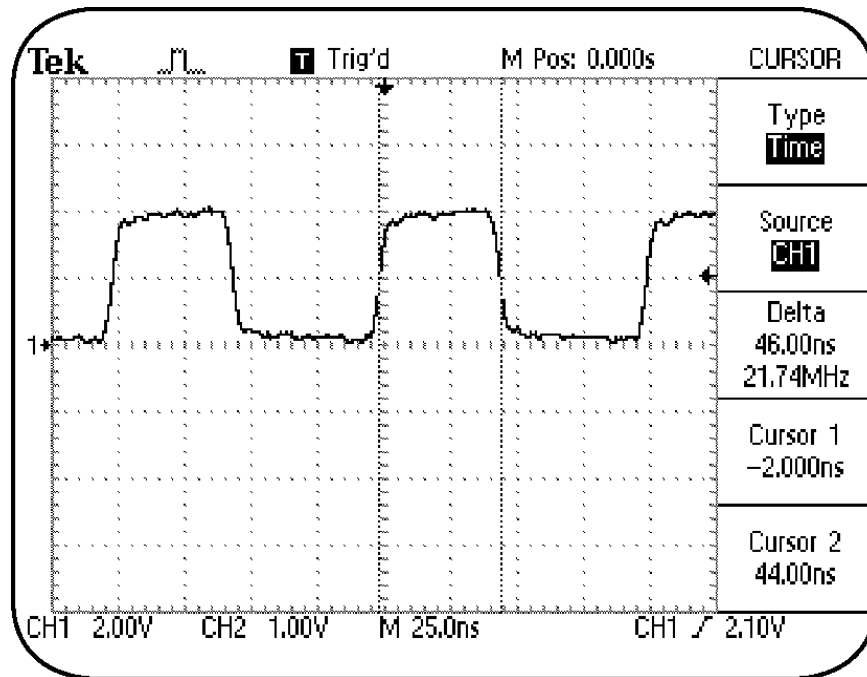

Figure 6.12: Pulse width measurements of a 10 MHz data signal using cursors

6

Using Menu Function Controls

Measuring Rise Time

Rise time is the time taken by the leading edge of a pulse to rise from 10% to 90% of its peak-to-peak amplitude.

You can measure the rise time of a pulse by using the **CURSOR** menu. In the following procedure, you manually measure the rise time of a pulse between 10% and 90% of the pulse amplitude by using time cursors.

***Note:** This procedure assumes that the oscilloscope retains the settings from the previous procedure.*

To measure the rise time of a pulse, follow these steps:

1. In the **VERTICAL** section, turn the **Channel 1 VOLTS/DIV** knob to set CH1 for **1.00V**.
2. Push the **CH1 MENU** button.
3. Turn the **Channel 1 POSITION** knob to position the waveform at center of the display.

4. In the **HORIZONTAL** section, turn the **SEC/DIV** knob to set the time base to **M 5.00ns** on the display.
5. Push the appropriate side-screen menu button to select **Volts/Div Fine**.
6. In the **VERTICAL** section, turn the **Channel 1 VOLTS/DIV** knob to set the waveform baseline amplitude to five divisions of the graticule.
7. Turn the **Channel 1 POSITION** knob to position the waveform at the center of the display such that the top baseline of the waveform is 2.5 divisions above the center graticule.
8. On the top of the front panel, push the **CURSOR** menu button.
9. Push the appropriate side-screen menu button to select **Type Time**.

This option may already be selected by default.

6

Using Menu Function Controls

10. In the **VERTICAL** section, turn the **Channel 1 POSITION** knob to position the associated cursor at the point where the waveform crosses the second graticule below the center of the screen.

This is the 10% point on the waveform.

11. Turn the **Channel 2 POSITION** knob to position the associated cursor at the point where the waveform crosses the second graticule above the center of the screen.

This is the 90% point on the waveform.

12. Read the rise time measurement for the pulse in the side-screen menu box **Delta**.

You will see a display similar to that shown in Figure 6.13. The measurement displayed in **Delta** is the rise time for the **D-10 MHz** signal from pin 3 on the Training 1 signal board.

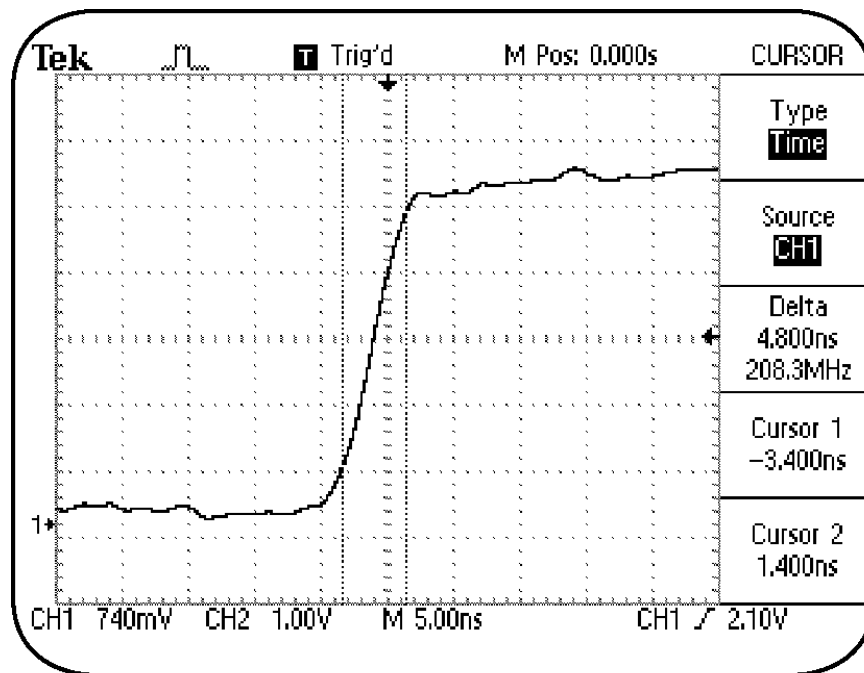

Figure 6.13: Rise time measurement of a 10MHz data signal

6

Using Menu Function Controls

MEASURE Menu Function Controls

You can take various automatic measurements with a TDS200 oscilloscope. You use the **MEASURE** menu function controls to take automatic measurements, such as signal frequency, period, rise time, fall time, positive width and amplitude, of most displayed signals. Out of the nine possible measurements, you can take a maximum of four measurements at a time. You can take each measurement on any input channel that is currently selected.

Note: *The TDS2MM module must be installed for rise time, fall time, and pulse width measurements.*

Taking Automatic Measurements

In the following procedure, you take automatic measurements to calculate the frequency, peak-to-peak, mean, and period of a waveform.

To measure the frequency, peak-to-peak, mean, and period of a waveform automatically, follow these steps:

1. Connect the CH1 probe tip to the **CLK 20MHz** signal on pin 2 and the CH1 probe ground lead to **GND** on pin 1 of the Training 1 signal board.

2. On the Training 1 signal board, push the **POWER** button until the **Digital PWR** light is on.
3. On the top of the front panel, push the **SAVE/RECALL** menu button.
4. Push the appropriate side-screen menu buttons to select **Setups** and then select **Recall Factory**.
5. On the top of the front panel, push the **AUTOSET** button.
6. On the top of the front panel, push the **MEASURE** menu button.
7. Push the appropriate side-screen menu button to select **Source**.
8. Push the appropriate side-screen menu buttons to select **CH1** for all measurements.
9. Push the appropriate side-screen menu button to select **Type**.

6

Using Menu Function Controls

10. Push the appropriate side-screen menu buttons to select **Freq** for the first measurement, **Period** for the second measurement, **Mean** for the third measurement, and **Pk-Pk** for the fourth measurement.

You will see a display of measurements similar to that shown in Figure 6.14.

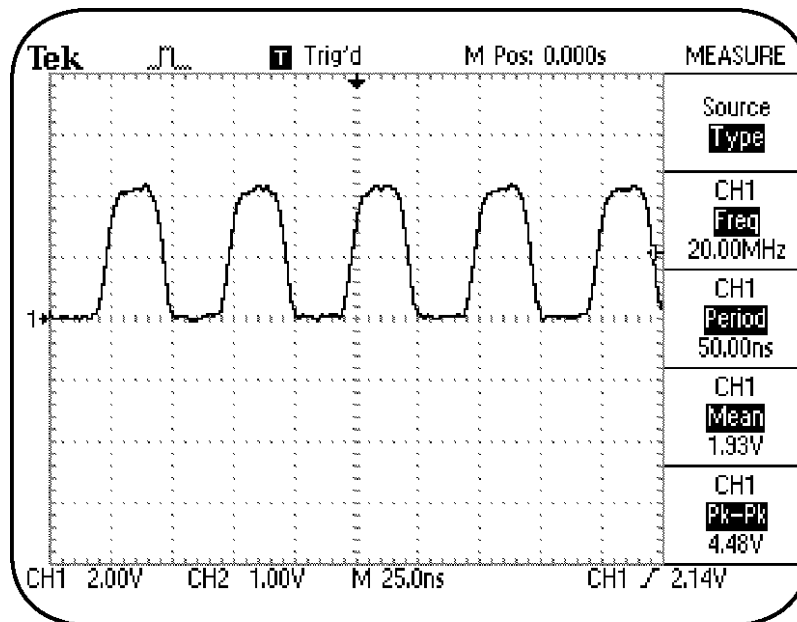

Figure 6.14: Square waveform with four automatic measurements

The frequency, period, mean, and peak-to-peak measurements for the CH1 input signal are shown in the side-screen menu. The oscilloscope sweeps the signal horizontally and the measurements are updated automatically.

SAVE/RECALL Menu Function Controls

You use the **SAVE/RECALL** menu function controls to save and recall a number of setups and waveforms. You can save and recall up to five instrument setups. In addition, you can also save and recall up to two reference memory locations for waveforms.

Note: *On the TDS224 oscilloscope, you can save and recall up to four waveforms. However, you can display only two waveforms at a time.*

Saving and Recalling a Setup

The following procedure enables you to save custom settings in a TDS200 oscilloscope by storing an instrument setup.

To save an instrument setup, follow these steps:

1. Connect the CH1 probe tip to the **5 KHZ SINE** signal on pin 10 and the CH1 ground lead to **GND** on pin 8 of the Training 1 signal board.

6

Using Menu Function Controls

2. On the Training 1 signal board, push the **POWER** button until only the **Analog PWR** light is on.
3. On the top of the front panel, push the **SAVE/RECALL** menu button.
4. Push the appropriate side-screen menu buttons to select **Setups** and then select **Recall Factory**.
5. On the top of the front panel, push the **AUTOSET** button.
6. In the **VERTICAL** section, push the **CH1 MENU** button.
7. Push the appropriate side-screen menu button to select **Volts/Div Fine**.
8. In the **VERTICAL** section, turn the **Channel 1 VOLTS/DIV** knob counter-clockwise to set CH1 for **256mV** on the display.
9. On the top of the front panel, push the **CURSOR** menu button.
10. Push the appropriate side-screen menu button to select **Type Voltage**.

11. In the HORIZONTAL section, push the **HORIZONTAL MENU** button.
12. Push the appropriate side-screen menu button to select **Window Zone**.
13. On the top of the front panel, push the **SAVE/RECALL** menu button.
14. Push the appropriate side-screen menu button to select **Setups**.
15. Push the appropriate side-screen menu button to select **Setup 1**.
16. Push the appropriate side-screen menu button to select **Save**.

Your instrument setup is saved.

6

Using Menu Function Controls

You will see a display similar to that shown in Figure 6.15.

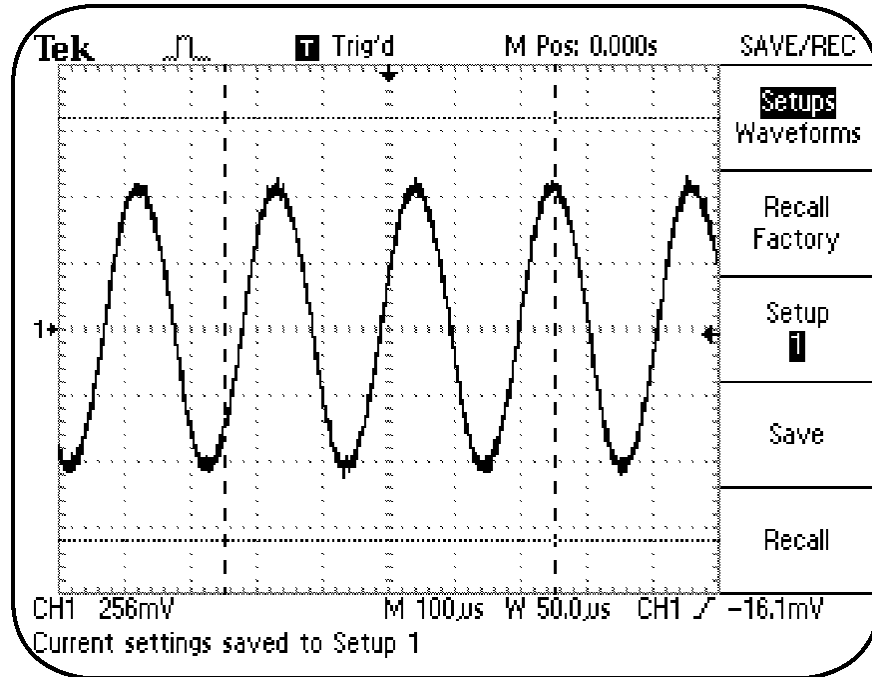

Figure 6.15: Saving an instrument setup

To recall a setup, follow these steps:

1. On the top of the front panel, push the **SAVE/RECALL** menu button.
2. Push the appropriate side-screen menu button to select **Setups**.

3. Push the appropriate side-screen menu button to select **Recall Factory**.
4. Push the appropriate side-screen menu button to select **Setup 1**.
5. Push the appropriate side-screen menu button to select **Recall**.

You should again see a display as shown in Figure 6.15.

In these procedures, you saved a specific measurement setup and recalled it from the setup location **Setup 1**.

Saving and Recalling a Waveform

The following procedure enables you to save and recall a waveform.

***Note:** This procedure assumes that the oscilloscope retains the settings from the previous procedure.*

To save and recall a waveform, follow these steps:

1. On the top of the front panel, push the **SAVE/RECALL** menu button.

6

Using Menu Function Controls

2. Push the appropriate side-screen menu buttons to select **Setups** and then **Recall Factory**.
3. On the top of the front panel, push the **AUTOSET** button.
4. Push the appropriate side-screen menu button to select **Waveforms**.
5. Push the appropriate side-screen menu button to select **Source CH1**.

This option may already be selected by default.

6. Push the appropriate side-screen menu button to select **Ref A**.

This option may already be selected by default.

7. Push the appropriate side-screen menu button to select **Save**.

8. In the **VERTICAL** section, turn the **Channel 1 POSITION** knob to position the displayed waveform one division above its current position.
9. Push the appropriate side-screen menu button to select **Ref A On**.
10. The displayed waveform is saved in the reference location **Ref A**.

You will see a display similar to that shown in Figure 6.16. Note that both the saved and the updating CH 1 waveforms are displayed.

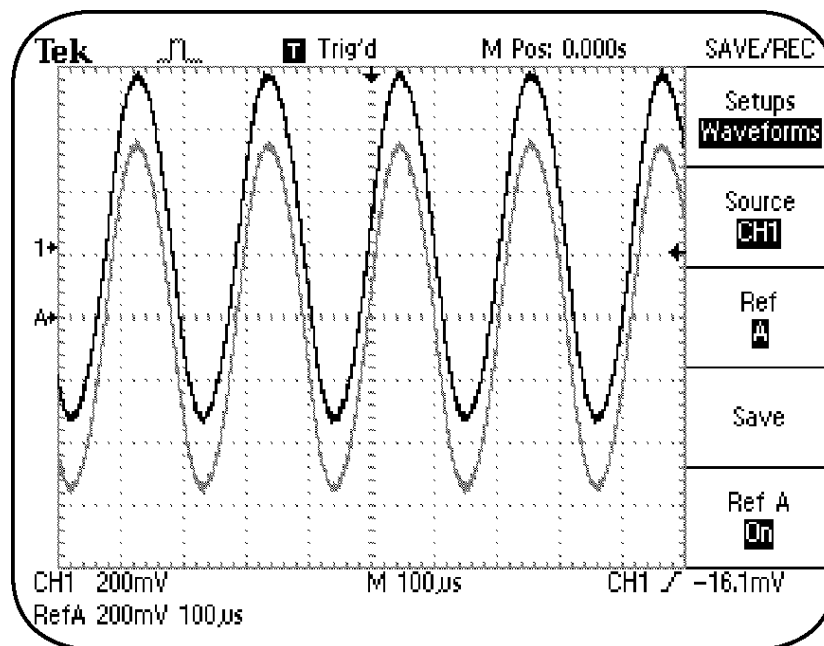

Figure 6.16: Saved and updating waveforms displayed

6

Using Menu Function Controls

UTILITY Menu Function Controls

You use the **UTILITY** menu function controls to access the different utility menus of a TDS200 oscilloscope. The **UTILITY** menu allows access to various tasks, such as displaying the system status for the different control sections of the oscilloscope, changing the display language, setting up the RS232 communications port, and checking the oscilloscope error log.

Displaying the System Status

In the following procedure, you check the status of **VERTICAL** controls.

To check the status of **VERTICAL** controls, follow these steps:

1. On the top of the front panel, push the **UTILITY** menu button.
2. Push the appropriate side-screen menu button to select **System Status**.

3. Push the appropriate side-screen menu button to select **Vertical**.

For the TDS224 oscilloscope, you will select either **Vertical CH1 CH2** or **Vertical CH3 CH4**.

You will see a display similar to that shown in Figure 6.17. The **Vertical System Status** is displayed.

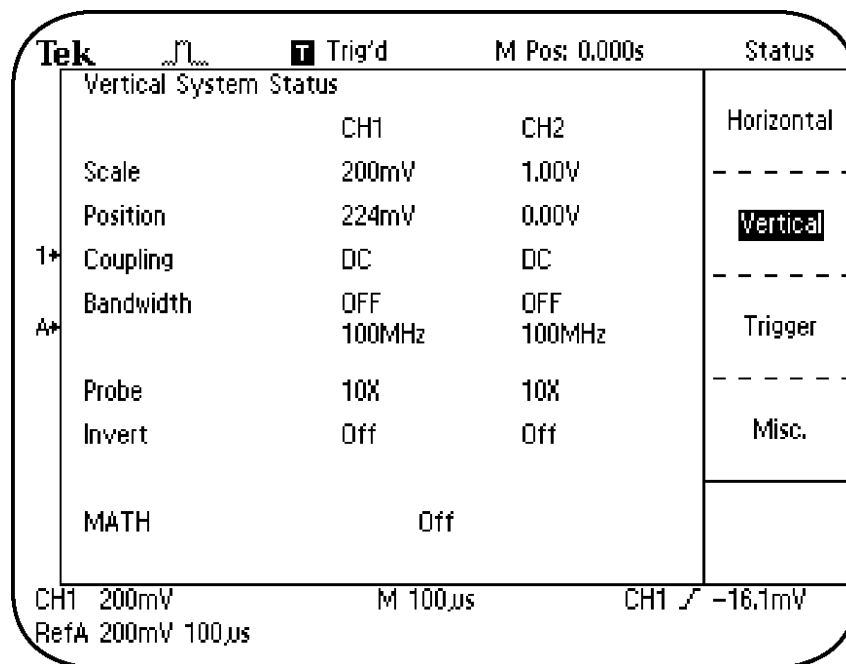

Figure 6.17: TDS200 Vertical System Status display

6

Using Menu Function Controls

In the following procedure, you will change the display language of a TDS200 oscilloscope.

To change the display language, follow these steps:

1. On the top of the front panel, push the **UTILITY** menu button.
2. Push the appropriate side-screen menu button to select the required language.

All side-screen menu options are displayed in the selected language.

Summary

In this module, you learned to use the menu options for the following menu function controls:

- **ACQUIRE**
- **DISPLAY**
- **CURSOR**
- **MEASURE**
- **SAVE/RECALL**
- **UTILITY**

You have now completed all chapters of the TDS 200 Series Oscilloscope Operator Training Kit.

Tektronix congratulates you for your work to be a better oscilloscope user.

Appendix A

Training 1 Signal Board: Signal Definitions

Appendix A

Training 1 Signal Board: Signal Definitions

Following is the regulatory compliance information for the Training 1 signal board.

European Union	EC Council EMC Directive 89/336/EEC, amended by 93/68/EEC. Demonstrated using: <ul style="list-style-type: none">• IEC 61326:1997 Product Family Standard for Electrical Equipment for Measurement, Control, and Laboratory Use- EMC Requirements• IEC 61000-3-2: AC Powerline Harmonic Emissions
Australia and New Zealand	EMC Framework, demonstrated per Emission Standard AS/NZS 2064 (Industrial, Scientific, and Medical Equipment).
USA	Complies with the requirements of FCC, CFR Title 47, Part 15, Subpart B, Class A.

Appendix A

Training 1 Signal Board: Signal Definitions

Figure A1.1 depicts the layout of the Training 1 signal board.

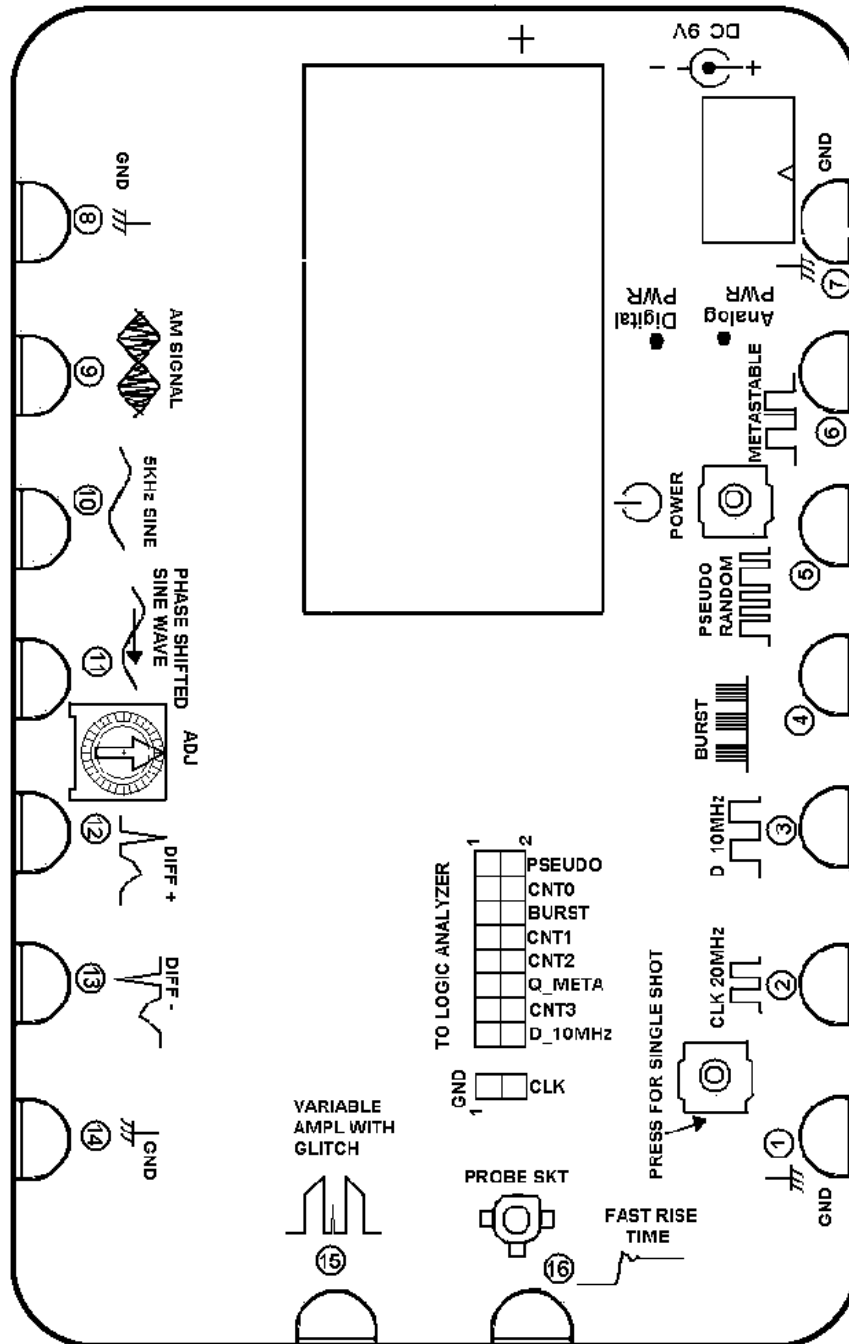

Figure A1.1: Training 1 signal board

Appendix A

Training 1 Signal Board: Signal Definitions

Pins 1, 7, 8, and 14	GND
Description	These pins provide the ground reference for the Training 1 signal board.
Pin 2	CLK 20 MHz
Specification	20 MHz digital signal, 4 V peak-to-peak
Description	This signal is the control clock for all of the digital signals on the Training 1 signal board.
Pin 3	D_10 MHz
Specification	10 MHz digital signal, 4 V peak-to-peak
Description	This signal is a 10 MHz digital data signal.
Pin 4	BURST (also found on the 2x8 pin connector)
Specification	Digital signal, 4 V peak-to-peak
Description	This signal is a repetitive pulse stream consisting of four groups of eight 16 to 24 ns pulses separated by 1.3 ms of inactivity. Verification of this signal requires two measurements at two different time scales.

Appendix A

Training 1 Signal Board: Signal Definitions

Pin 5	PSEUDO RANDOM
Specification	20 MHz digital clock signal, 3 V peak-to-peak
Description	This NRZ/OC1 pseudo random signal can be used to show how to trigger on a complex yet repeating signal sequence, such as a communication signal or computer control signal, with the use of trigger holdoff on a TDS200 or a TDS3000 oscilloscope.
Pin 6	METASTABLE
Specification	Digital signal, 3 V peak-to-peak
Description	This signal is a 10 MHz square wave that contains an occasional glitch caused by a metastable state in the flip-flop. A logic analyzer or an advanced oscilloscope set to trigger on narrow pulse widths will find these glitches.

Appendix A

Training 1 Signal Board: Signal Definitions

Pin 9	AM SIGNAL
Specification	Analog signal Frequency: 5 kHz sine wave with 1 MHz carrier Amplitude: 3 V peak-to-peak
Description	This amplitude modulated signal uses a 5 kHz sine wave signal source and a 1 MHz carrier frequency. The output should look like a sine wave with a positive DC component and an inverted sine wave with a negative DC component with shading between. This signal can be used to show the varying characteristics of one signal being amplitude modulated onto another signal, such as in radio frequency applications. These characteristics can be shown on a TDS200 or a TDS3000 oscilloscope by using trigger holdoff and variable persistence.
Pins 10 and 11	5 kHz SINE and PHASE SHIFTED SINE WAVE
Specification	Analog signal Positive phase shift: 0–135 degrees Frequency: About 5 kHz Amplitude: 1 V

Appendix A

Training 1 Signal Board: Signal Definitions

Description The phase difference between these two 5 kHz sine waves is varied using a potentiometer. The maximum phase shift between the two sine waves is determined by turning the potentiometer to both extremes. This set of signals can be used to demonstrate the phase relationship of two time related signals, such as voltage and current in a power supply, by using the **X/Y** display mode on a TDS200 or a TDS3000 oscilloscope.

Pins 12 and 13 DIFF + and DIFF –

Specification Analog signals

Frequency: 7 Hz, with 1Hz background

Amplitude: 2 V common with 250 mV differential

Description The differential signal from pins 12 and 13 is a 1 Hz heartbeat signal with a 250 mV amplitude. It is combined with a 2 Volt common mode 7 Hz sine wave. This signal can be used to demonstrate how to separate differential signals from common mode signals. Subtracting one channel from another on a TDS200 or a TDS3000 oscilloscope can reject common mode signals.

Appendix A

Training 1 Signal Board: Signal Definitions

Pin 15	VARIABLE AMPL WITH GLITCH
Specification	Analog signal Frequency: 10 Hz Amplitude: Variable between 1 V and 4 V, following sine wave at 0.1Hz rate 20ns asynchronous glitch, 5V amplitude, at 1Hz rate
Description	This signal is a 10 Hz square wave with an amplitude that follows a 0.1 Hz sine wave. In addition, a +5 VDC 20 ns pulse combines with the signal at an asynchronous 1 Hz rate. The glitch is visible on an oscilloscope if the sweep speed is increased and set to trigger on a narrow pulse. This signal can be used to demonstrate how to capture and analyze infrequent high-speed glitches with the use of the Peak Detect acquisition mode on a TDS200 or a TDS3000 oscilloscope.
Pin 16	FAST RISE TIME
Specification	Analog signal Amplitude: About 0.6 V 1 ns to 2 ns rise time

Appendix A

Training 1 Signal Board: Signal Definitions

Description	This signal is a 100 ns wide 0.6 Volt pulse with a rise time of <2 ns. The signal is generated each time the PRESS FOR SINGLE SHOT button is pressed on the Training 1 signal board. This signal can be used to demonstrate the unwanted effects of the ground lead when probing high speed circuits.
2x8 Pin Connector	D_10MHz: Duplicate of the 10 MHz data signal from pin 3. Q_META: Duplicate of the METASTABLE signal from pin 6. PSEUDO: Duplicate of the PSEUDO RANDOM signal from pin 5. CNT0, CNT1, CNT2, and CNT3: This signal is a 10 MHz count pattern that is run continuously

Appendix B

Glossary

Term	Description
AC Coupling	A mode that blocks the DC component of a signal but passes the dynamic (AC) component of the signal. Useful for observing an AC signal that is normally riding on a DC signal.
Acquisition	The process of sampling signals from input channels, digitizing the samples, processing the results into data points, and assembling the data points into a waveform record. The waveform record is stored in memory.
Attenuation	The degree the amplitude of a signal is reduced when it passes through an attenuating device such as a probe or attenuator (the ratio of the input measure to the output measure).
Auto Trigger Mode	A trigger mode that causes the oscilloscope to automatically acquire if it does not detect a valid trigger event.

Appendix B

Glossary

- Autoset** A feature that automatically sets the vertical, horizontal, and trigger controls to provide a usable display.
- Average Acquisition Mode** A mode in which the oscilloscope acquires and displays a waveform that is the averaged result of several acquisitions. The oscilloscope acquires data as in the sample mode and then averages it according to a specified number of averages. Averaging reduces uncorrelated noise in the displayed signal.
- Bandwidth** The frequency range of an oscilloscope used to measure a sine wave signal accurately. Bandwidth specifies the frequency at which the displayed sine wave reduces to 70.7% of the applied sine wave signal amplitude.

Appendix B

Glossary

B Trigger	A second trigger that occurs after a given time or number of events from the main A trigger. The B trigger can be used in combination with the A trigger to capture complex events.
Complex Wave	Combines the characteristics of sine waves, square waves, step waves, and pulse waves.
Cursors	Paired markers that you can use to make measurements between two waveform locations. The oscilloscope displays the values (expressed in volts, time, or frequency) of the position of the active cursor and the distance between the two cursors.
DC Coupling	A mode that passes both AC and DC signal components to the circuit. Available for both the trigger system and the vertical system.

Appendix B

Glossary

Delay	A means to delay the acquisition to start after the trigger event has occurred. The trigger point need not be within a waveform when delay is on.
Display	The word used to refer to the screen of the oscilloscope.
Edge Trigger	Triggering that occurs when the oscilloscope detects the source passing through a specified voltage level in a specified direction (the trigger slope).
Envelope Acquisition Mode	An acquisition mode in which a TDS3000 oscilloscope acquires and displays a waveform that shows the variation extremes of several acquisitions.
External Trigger	Triggering that occurs when the oscilloscope detects the external input signal passing through a specified voltage level in a specified direction.

Appendix B

Glossary

Frequency	Represents the number of times a signal repeats itself in one second. The frequency of a signal is measured in Hertz (Hz).
Ground (GND) Coupling	Coupling option that disconnects the input signal from the vertical system.
Ground Lead	The ground reference lead for an oscilloscope probe.
Hard Copy	An electronic copy of the display in a format useable by a printer or plotter.
Holdoff	A specified amount of time that must elapse after a trigger signal before the trigger circuit will accept another trigger signal. Holdoff helps ensure a stable display.
Horizontal Cursors	The two horizontal bars that you position to measure the voltage parameters of a waveform. The oscilloscope displays the value of the active (moveable) cursor with respect to ground and the voltage value between the bars.

Appendix B

Glossary

Normal Trigger Mode	A mode where the oscilloscope does not acquire a waveform record unless a valid trigger event occurs. It waits for a valid trigger event before acquiring waveform data.
Peak Detect Acquisition Mode	An acquisition mode that captures spikes and glitches that may occur between normal sample points. A mode in which the oscilloscope creates a pair of record points during each sample interval. Each pair consists of the maximum and minimum input voltage during the interval.
Period	A period is the time in which a signal completes one cycle.
Persistence	A method of retaining old data on the display for a period of time. With persistence turned off, the points decay quickly. With persistence on, the points decay more slowly or not at all.
Phase	Movement of a sine wave through 360° in one cycle. Used to calculate the elapsed time from the reference or beginning point of the sine wave.

Appendix B

Glossary

Phase Shift	Refers to the degrees of difference between two similar synchronous signals.
Pretrigger	The specified portion of the waveform record that contains data acquired before the trigger event.
Pulse Wave	Represents a sudden change in signal level followed by a return to the original level.
QuickMenu	An alternate display presentation in a TDS3000 oscilloscope that lets you control the most commonly used functions with the bottom- and side-screen menu buttons.
RS-232	The serial communication port used to connect to a hard-copy device, computer, controller, or terminal.
Record Length	The specified number of samples in a waveform.
Rectangular Wave	Displayed when the high and low time periods of a square wave are unequal.

Appendix B

Glossary

Reference Waveform	A saved waveform selected for display. You can save and display up to four reference waveforms on a TDS200 or TDS3000 oscilloscope, depending on the model.
Rise Time	The time taken by a step or pulse to rise from 10% to 90% amplitude level.
Sample Acquisition Mode	A mode in which the oscilloscope samples and displays each recorded sample point. As more time is required for an acquisition with a fixed record length (by changing the time per division), the sample interval (the time between acquired samples) must increase. This in turn reduces the displayed sample rate.
Sample Interval	The time interval between successive samples in a waveform record. Changing the time base changes the sample interval.

Appendix B

Glossary

Sawtooth Wave	Has a rising rate of change that is different (faster or slower) from the falling rate of change.
Sine Wave	Basic waveform that represents voltage change with time. Signals produced by the oscillator circuit in a signal generator are sine waves. Most AC power sources produce sine waves.
Square Wave	Represents voltage signals that turn on and off at regular intervals. It is a standard wave for testing amplifiers, televisions, radios, and computer circuits.
Step Wave	Indicates a sudden change in voltage, which may be the result of turning on an electric switch.
Sweep Speed	The speed at which a waveform can sweep across the screen of an analog oscilloscope. The sweep speed of an oscilloscope is stated in time per division (sec/div).

Appendix B

Glossary

TekProbe Interface	An interface that communicates information, such as the probe type and its attenuation factor, between a probe and a TDS3000 oscilloscope. The interface also supplies power to active voltage probes.
Time Base	The set of parameters that let you define the time axis attributes of a waveform record. The time base determines how fast and how long to acquire record points.
Triangle Wave	Has a rising rate of change equal to the falling rate of change.
Vertical Cursors	The two vertical bars you position to measure the time parameter of a waveform record. The oscilloscope displays the value of the active cursor with respect to trigger and the time value between the bars.
Vertical Sensitivity	The range within which an amplifier can amplify a weak signal. Vertical sensitivity is stated in volts per division (volts/div).

Appendix B

Glossary

Video Trigger	Triggering on the line or field sync pulses of a composite video signal.
XY Format	A display format that compares the voltage level of two waveform records point by point. It is useful for studying phase relationships between two waveforms.
YT Format	The conventional oscilloscope display format. It shows the voltage of a waveform record (on the vertical axis) as it varies over time (on the horizontal axis).